

# SECTION WCS

## WARNING CHIME SYSTEM

A  
B  
C  
D  
E  
F  
G  
H  
I  
J  
K  
L  
M  
O  
P

### CONTENTS

<b>BASIC INSPECTION</b> .....	3	<b>PARKING BRAKE RELEASE WARNING CHIME</b> : System Description .....	11
<b>DIAGNOSIS AND REPAIR WORKFLOW</b> .....	3	<b>PARKING BRAKE RELEASE WARNING CHIME</b> : Component Parts Location .....	12
Work Flow .....	3	<b>PARKING BRAKE RELEASE WARNING CHIME</b> : Component Description .....	12
<b>SYSTEM DESCRIPTION</b> .....	5	<b>DIAGNOSIS SYSTEM (METER)</b> .....	14
<b>WARNING CHIME SYSTEM</b> .....	5	Diagnosis Description .....	14
<b>WARNING CHIME SYSTEM</b> .....	5	CONSULT Function (METER/M&A) .....	14
WARNING CHIME SYSTEM : System Diagram .....	5	<b>DIAGNOSIS SYSTEM (BCM)</b> .....	17
WARNING CHIME SYSTEM : System Description .....	5	<b>BUZZER</b> .....	17
WARNING CHIME SYSTEM : Component Parts Location .....	6	BUZZER : CONSULT Function (BCM - BUZZER)...	17
WARNING CHIME SYSTEM : Component De- scription .....	6	<b>DTC/CIRCUIT DIAGNOSIS</b> .....	18
<b>LIGHT REMINDER WARNING CHIME</b> .....	7	<b>POWER SUPPLY AND GROUND CIRCUIT</b> ....	18
LIGHT REMINDER WARNING CHIME : System Diagram .....	7	<b>COMBINATION METER</b> .....	18
LIGHT REMINDER WARNING CHIME : System Description .....	7	COMBINATION METER : Diagnosis Procedure ....	18
LIGHT REMINDER WARNING CHIME : Compo- nent Parts Location .....	8	<b>BCM (BODY CONTROL MODULE)</b> .....	18
LIGHT REMINDER WARNING CHIME : Compo- nent Description .....	8	BCM (BODY CONTROL MODULE) : Diagnosis Procedure .....	19
<b>SEAT BELT WARNING CHIME</b> .....	9	<b>METER BUZZER CIRCUIT</b> .....	20
SEAT BELT WARNING CHIME : System Diagram .....	9	Description .....	20
SEAT BELT WARNING CHIME : System Descrip- tion .....	9	Component Function Check .....	20
SEAT BELT WARNING CHIME : Component Parts Location .....	10	Diagnosis Procedure .....	20
SEAT BELT WARNING CHIME : Component De- scription .....	10	<b>SEAT BELT BUCKLE SWITCH SIGNAL CIR- CUIT</b> .....	21
<b>PARKING BRAKE RELEASE WARNING CHIME</b> ....	11	Description .....	21
PARKING BRAKE RELEASE WARNING CHIME : System Diagram .....	11	Component Function Check .....	21
		Diagnosis Procedure .....	21
		Component Inspection .....	22
		<b>ECU DIAGNOSIS INFORMATION</b> .....	23
		<b>COMBINATION METER</b> .....	23
		Reference Value .....	23

WCS

Fail Safe .....	26	Description .....	60
DTC Index .....	27	Diagnosis Procedure .....	60
<b>BCM (BODY CONTROL MODULE) .....</b>	<b>28</b>	<b>THE LIGHT REMINDER WARNING DOES</b>	
Reference Value .....	28	<b>NOT SOUND .....</b>	<b>61</b>
Terminal Layout .....	33	Description .....	61
Physical Values .....	33	Diagnosis Procedure .....	61
Fail Safe .....	49	<b>THE SEAT BELT WARNING CONTINUES</b>	
DTC Inspection Priority Chart .....	50	<b>SOUNDING, OR DOES NOT SOUND .....</b>	<b>62</b>
DTC Index .....	51	Description .....	62
<b>WIRING DIAGRAM .....</b>	<b>54</b>	Diagnosis Procedure .....	62
<b>WARNING CHIME SYSTEM .....</b>	<b>54</b>	<b>PRECAUTION .....</b>	<b>63</b>
Wiring Diagram .....	54	<b>PRECAUTIONS .....</b>	<b>63</b>
<b>SYMPTOM DIAGNOSIS .....</b>	<b>60</b>	Precaution for Supplemental Restraint System	
<b>THE PARKING BRAKE RELEASE WARNING</b>		(SRS) "AIR BAG" and "SEAT BELT PRE-TEN-	
<b>CONTINUES SOUNDING, OR DOES NOT</b>		SIONER" .....	63
<b>SOUND .....</b>	<b>60</b>		

# DIAGNOSIS AND REPAIR WORKFLOW

< BASIC INSPECTION >

## BASIC INSPECTION

### DIAGNOSIS AND REPAIR WORKFLOW

Work Flow

INFOID:0000000010049213

#### OVERALL SEQUENCE

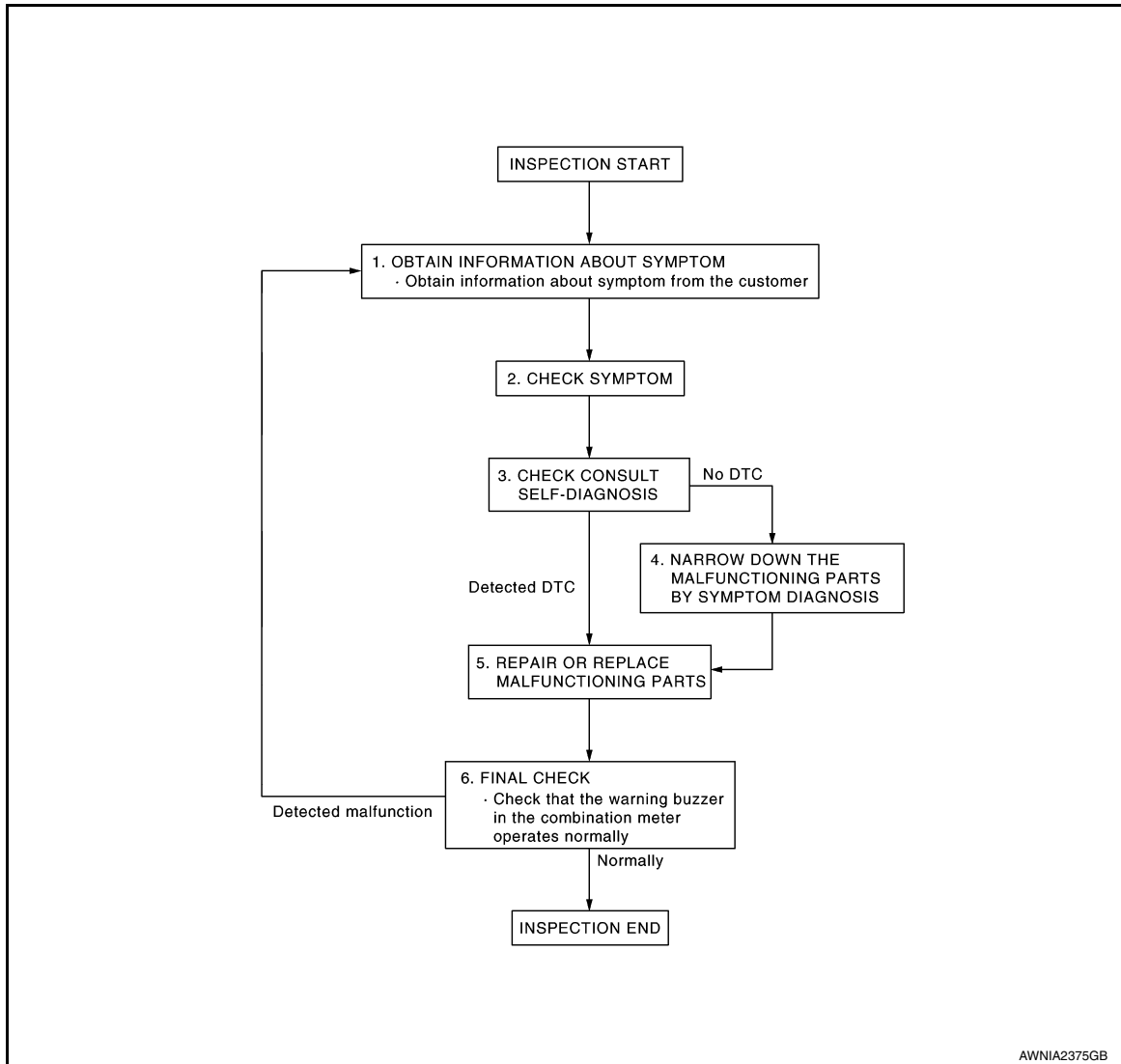

#### DETAILED FLOW

##### 1.OBTAIN INFORMATION ABOUT SYMPTOM

Interview the customer to obtain as much information as possible about the conditions and environment under which the malfunction occurred.

>> GO TO 2

##### 2.CHECK SYMPTOM

- Check the symptom based on the information obtained from the customer.
- Check to see if any other malfunctions are present.

>> GO TO 3

##### 3.CHECK CONSULT SELF-DIAGNOSIS RESULTS

A  
B  
C  
D  
E  
F  
G  
H  
I  
J  
K  
L  
M

WCS

O  
P

## DIAGNOSIS AND REPAIR WORKFLOW

### < BASIC INSPECTION >

Connect CONSULT and perform "SELF-DIAGNOSIS". Refer to [MWI-29. "CONSULT Function \(METER/M&A\)"](#).

Are self-diagnosis results normal?

YES >> GO TO 4

NO >> GO TO 5

### 4.NARROW DOWN MALFUNCTIONING PARTS THROUGH SYMPTOM DIAGNOSIS

---

Perform symptom diagnosis and repair or replace the identified malfunctioning parts.

>> GO TO 5

### 5.REPAIR OR REPLACE MALFUNCTIONING PARTS

---

Repair or replace malfunctioning parts.

**NOTE:**

If DTC is displayed, erase DTC after repairing or replacing malfunctioning parts.

>> GO TO 6

### 6.FINAL CHECK

---

Check that the warning buzzer in the combination meter operates normally.

Does it operate normally?

YES >> Inspection End.

NO >> GO TO 1

# WARNING CHIME SYSTEM

< SYSTEM DESCRIPTION >

## SYSTEM DESCRIPTION

### WARNING CHIME SYSTEM

### WARNING CHIME SYSTEM

### WARNING CHIME SYSTEM : System Diagram

INFOID:000000010049214

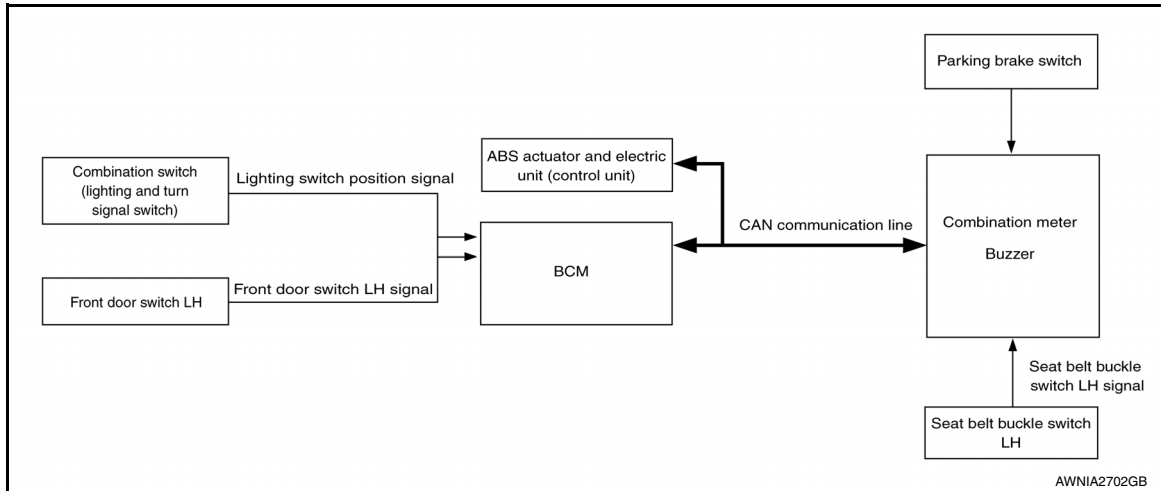

AWNIA2702GB

### WARNING CHIME SYSTEM : System Description

INFOID:000000010049215

#### COMBINATION METER

- The buzzer (1) for warning chime system is installed in the combination meter.
- The buzzer sounds when the combination meter receives a buzzer output signal from each unit.

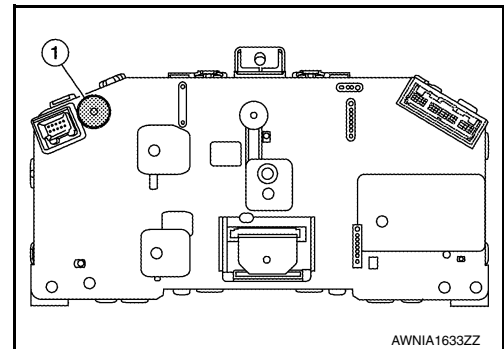

AWNIA1633ZZ

#### BCM

BCM receives signals from various units and transmits a buzzer output signal to the combination meter with CAN communication line if it judges that the warning buzzer should be activated.

#### BCM warning function list

Warning functions	Signal name
Light reminder warning chime	<ul style="list-style-type: none"> <li>• Lighting switch position signal</li> <li>• Front door switch LH signal</li> </ul>
Seat belt warning chime	Seat belt buckle switch LH signal

WCS

# WARNING CHIME SYSTEM

< SYSTEM DESCRIPTION >

## WARNING CHIME SYSTEM : Component Parts Location

INFOID:000000010049216

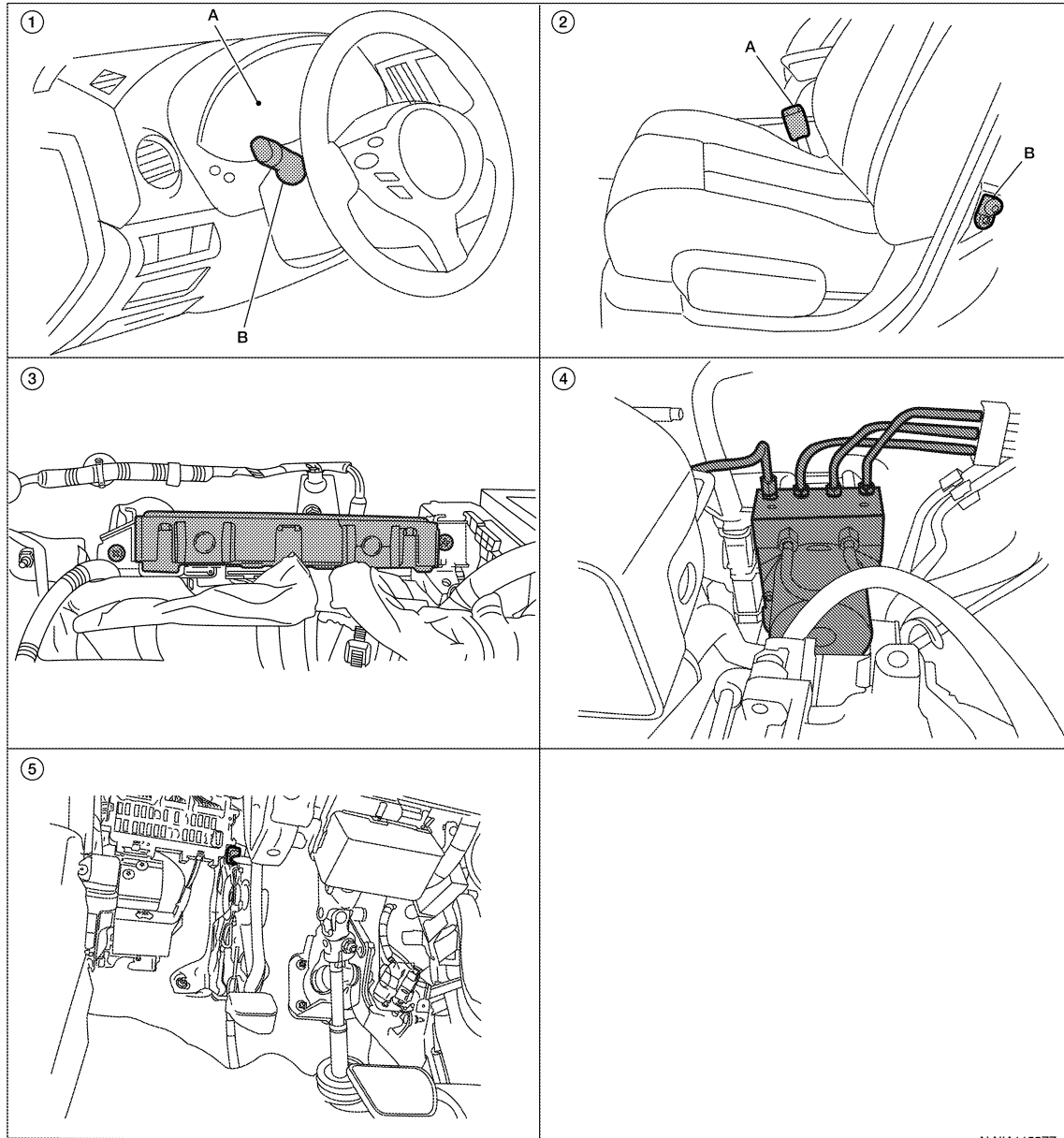

ALNIA1155ZZ

- |  |  |   |
|--|--|---|
| <p>1. A. Combination meter M24<br/>B. Combination switch (lighting and turn signal switch) M28</p> | <p>2. A. Seat belt buckle switch LH B202<br/>B. Front door switch LH B8</p>              | <p>3. BCM M16, M17, M18, M19 (view with instrument panel removed)</p> |
| <p>4. ABS actuator and electric unit (control unit) E26</p>  | <p>5. Parking brake switch E35 [view with instrument panel lower cover (LH) removed]</p> |   |

## WARNING CHIME SYSTEM : Component Description

INFOID:000000010049217

Unit	Description
Combination meter	<ul style="list-style-type: none"> <li>Judges whether the parking brake is released using the vehicle speed signal and the parking brake switch signal, and sounds the buzzer if necessary.</li> <li>Receives the seat belt buckle switch LH signal from the seat belt buckle switch LH and transmits it to BCM with CAN communication line.</li> <li>Receives a buzzer output signal from BCM with CAN communication line.</li> </ul>
BCM	Transmits signals provided by various units to the combination meter with CAN communication line.

# WARNING CHIME SYSTEM

## < SYSTEM DESCRIPTION >

Unit	Description
ABS actuator and electric unit (control unit)	Transmits the vehicle speed signal to combination meter with CAN communication line.
Seat belt buckle switch LH	Transmits a seat belt buckle switch LH signal to the combination meter.
Combination switch (lighting and turn signal switch)	Transmits the lighting switch position signal to BCM.
Front door switch LH	Transmits the front door switch LH signal to BCM.
Parking brake switch	Transmits parking brake signal to combination meter.

## LIGHT REMINDER WARNING CHIME

### LIGHT REMINDER WARNING CHIME : System Diagram

INFOID:000000010049218

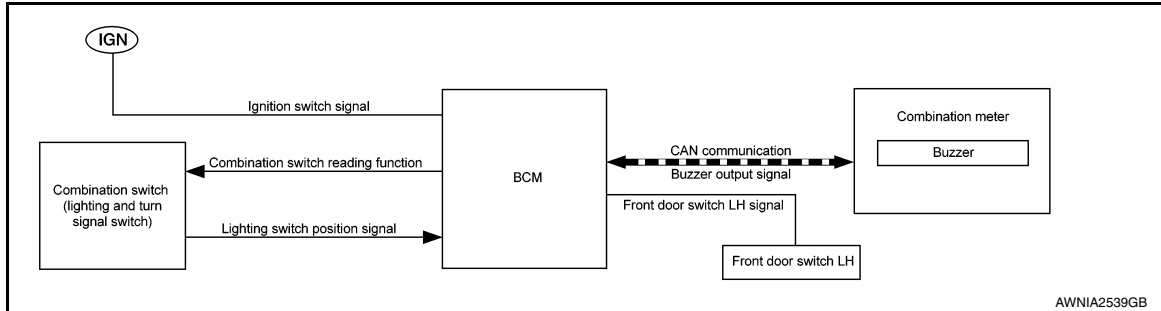

### LIGHT REMINDER WARNING CHIME : System Description

INFOID:000000010049219

#### DESCRIPTION

With ignition switch in OFF or ACC position, driver door open, and lighting switch in 1ST or 2ND position, the light warning chime will sound.

- BCM detects ignition switch in OFF or ACC position, front door switch LH ON, and lighting switch in 1ST or 2ND position and then transmits buzzer output signal (light reminder warning chime) to combination meter with CAN communication line.
- When combination meter receives buzzer output signal (light reminder warning chime), it sounds the buzzer.

#### WARNING OPERATION CONDITIONS

If all of the following conditions are fulfilled

- Lighting switch is at 1st or 2nd position
- Ignition switch is at OFF or ACC
- Front door switch LH is ON

#### WARNING CANCEL CONDITIONS

Warning is canceled if any of the following conditions is fulfilled.

- Lighting switch OFF
- Ignition switch ON
- Front door switch LH is OFF

A  
B  
C  
D  
E  
F  
G  
H  
I  
J  
K  
L  
M  
O  
P

WCS

# WARNING CHIME SYSTEM

< SYSTEM DESCRIPTION >

## LIGHT REMINDER WARNING CHIME : Component Parts Location

INFOID:000000010049220

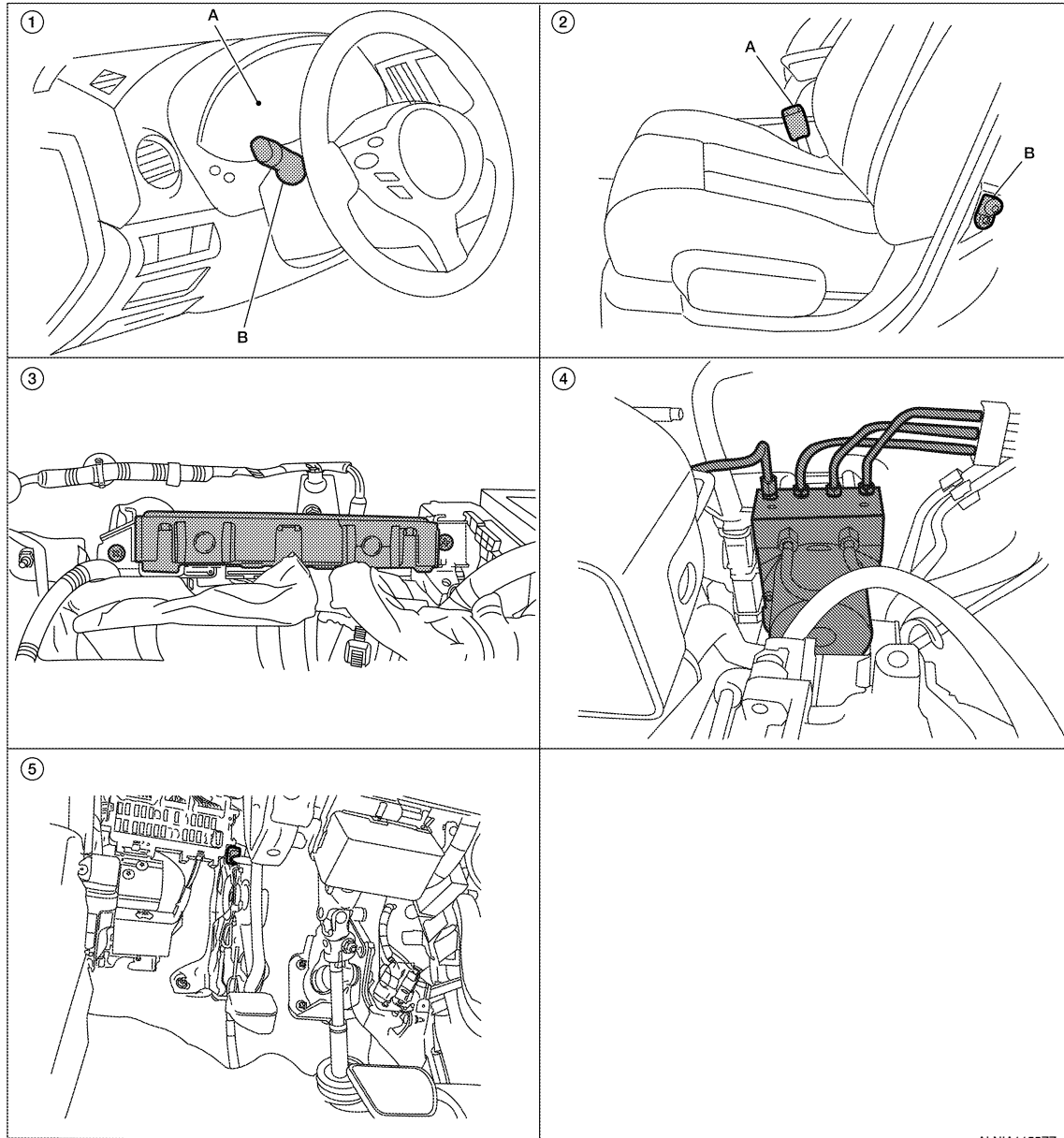

ALNIA1155ZZ

- |  |  |   |
|--|--|---|
| <p>1. A. Combination meter M24<br/>B. Combination switch (lighting and turn signal switch) M28</p> | <p>2. A. Seat belt buckle switch LH B202<br/>B. Front door switch LH B8</p>              | <p>3. BCM M16, M17, M18, M19 (view with instrument panel removed)</p> |
| <p>4. ABS actuator and electric unit (control unit) E26</p>  | <p>5. Parking brake switch E35 [view with instrument panel lower cover (LH) removed]</p> |   |

## LIGHT REMINDER WARNING CHIME : Component Description

INFOID:000000010049221

Unit	Description
Combination meter	Receives a buzzer output signal from BCM via CAN communication line and sounds the buzzer.
BCM	Judges the light warning conditions from the signals provided by various switches and transmits a buzzer output signal to the combination meter via CAN communication line if necessary.
Combination switch (lighting and turn signal switch)	Transmits the lighting switch position signal to BCM.
Front door switch LH	Transmits the front door switch LH signal to BCM.



# WARNING CHIME SYSTEM

< SYSTEM DESCRIPTION >

## SEAT BELT WARNING CHIME

### SEAT BELT WARNING CHIME : System Diagram

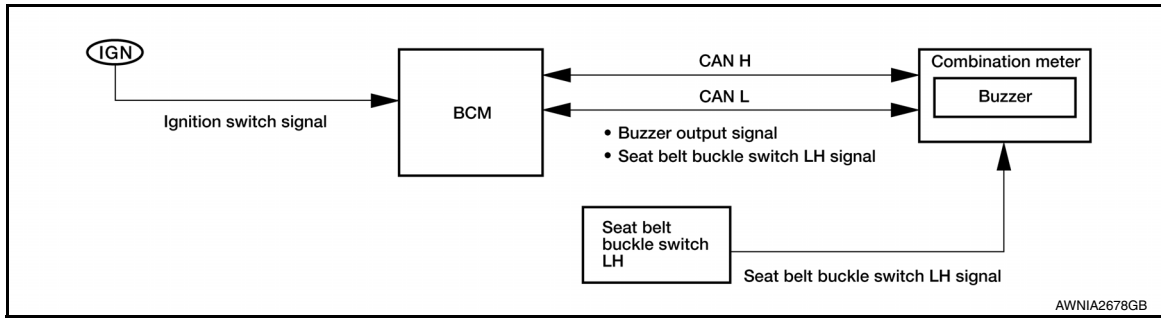

### SEAT BELT WARNING CHIME : System Description

INFOID:000000010049223

#### DESCRIPTION

With ignition switch turned ON and driver seat belt unfastened, seat belt warning chime will sound for approximately 6 seconds.

- BCM receives seat belt buckle switch LH signal from combination meter with CAN communication line.
- BCM detects ignition switch turned ON and seat belt buckle switch LH ON and then transmits buzzer output signal (seat belt warning chime) to combination meter with CAN communication line.
- When combination meter receives buzzer output signal (seat belt warning chime), it sounds the buzzer.

#### WARNING OPERATION CONDITIONS

If all of the following conditions are fulfilled

- Ignition switch OFF → ON
- Seat buckle switch LH is ON (driver seat belt not fastened)

#### WARNING CANCEL CONDITIONS

Cancels the warning if any of the following conditions is fulfilled.

- Ignition switch OFF
- Seat buckle switch LH is OFF (driver seat belt fastened)
- 90 seconds have passed since the start of the warning

A  
B  
C  
D  
E  
F  
G  
H  
I  
J  
K  
L  
M  
O  
P

WCS

# WARNING CHIME SYSTEM

< SYSTEM DESCRIPTION >

## SEAT BELT WARNING CHIME : Component Parts Location

INFOID:000000010049224

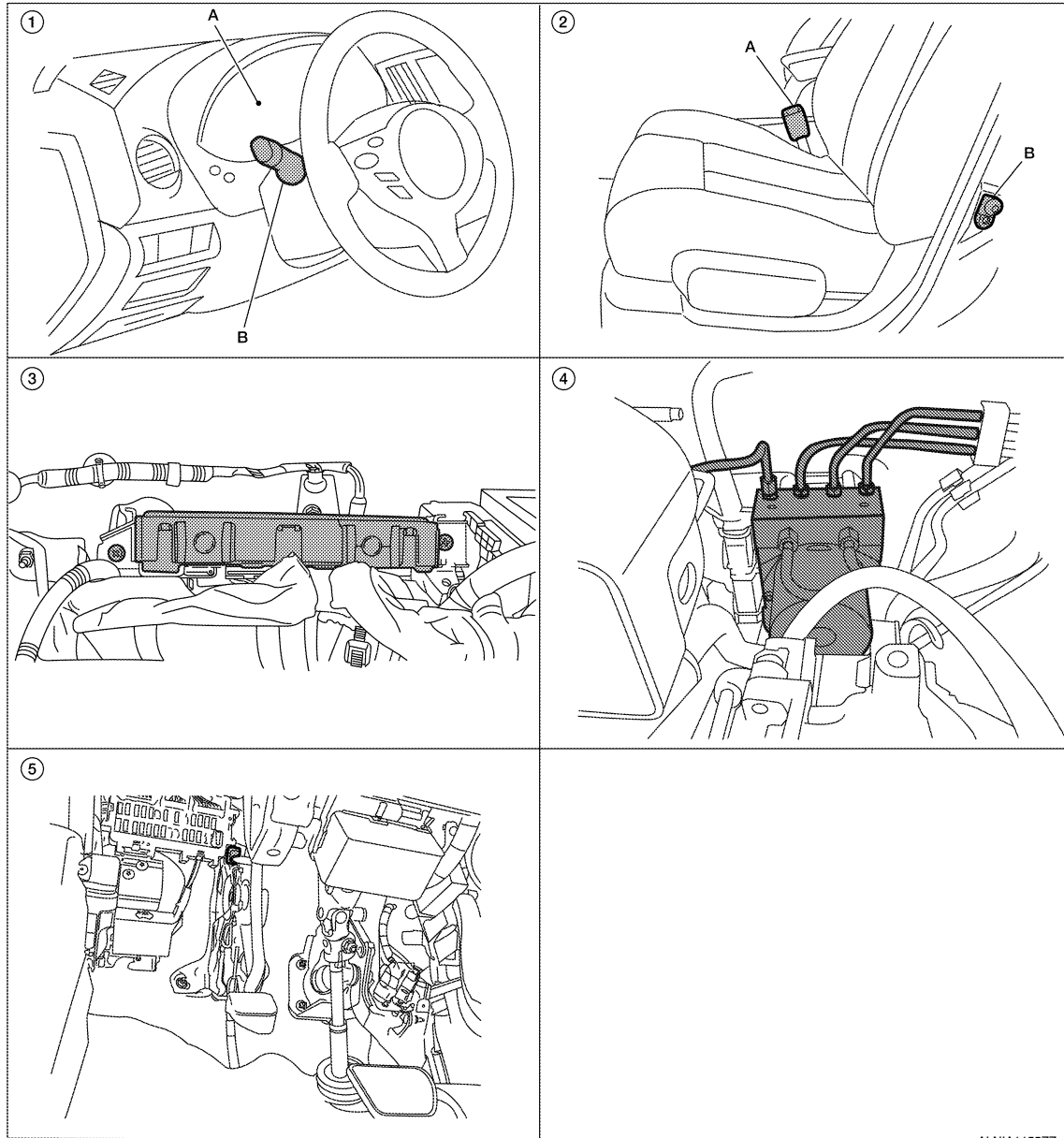

ALN1A1155ZZ

- |  |  |   |
|--|--|---|
| <p>1. A. Combination meter M24<br/>B. Combination switch (lighting and turn signal switch) M28</p> | <p>2. A. Seat belt buckle switch LH B202<br/>B. Front door switch LH B8</p>              | <p>3. BCM M16, M17, M18, M19 (view with instrument panel removed)</p> |
| <p>4. ABS actuator and electric unit (control unit) E26</p>  | <p>5. Parking brake switch E35 [view with instrument panel lower cover (LH) removed]</p> |   |

## SEAT BELT WARNING CHIME : Component Description

INFOID:000000010049225

Unit	Description
Combination meter	<ul style="list-style-type: none"> <li>Receives the seat belt buckle switch LH signal from the seat belt buckle switch LH and transmits it to BCM via CAN communication line.</li> <li>Receives a buzzer output signal from BCM via CAN communication line and sounds the buzzer.</li> </ul>
BCM	Judges the seat belt warning condition from the seat belt buckle switch LH signal received from the combination meter and transmits a buzzer output signal to the combination meter via CAN communication line if necessary.
Seat belt buckle switch LH	Transmits seat belt buckle switch LH signal to combination meter.

# WARNING CHIME SYSTEM

< SYSTEM DESCRIPTION >

## PARKING BRAKE RELEASE WARNING CHIME

### PARKING BRAKE RELEASE WARNING CHIME : System Diagram

INFOID:000000010049226

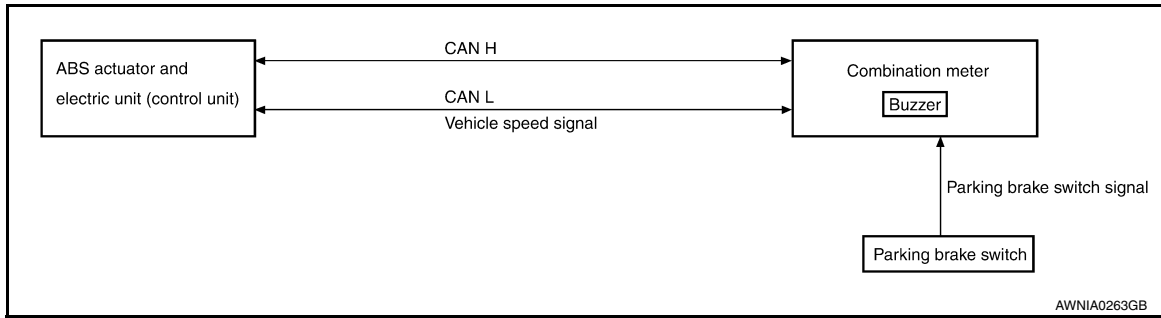

### PARKING BRAKE RELEASE WARNING CHIME : System Description

INFOID:000000010049227

#### DESCRIPTION

- The combination meter receives the vehicle speed signal from the ABS actuator and electric unit (control unit) via CAN communication line.
- The combination meter judges whether the parking brake is released using the parking brake switch signal from the parking brake switch, and sounds the warning buzzer if necessary.

#### WARNING OPERATION CONDITIONS

If all of the following conditions are fulfilled

- Vehicle speed is approximately 7 km/h (4.3 MPH) or higher
- Parking brake switch ON

#### WARNING CANCEL CONDITIONS

Warning is canceled if any of the following conditions is fulfilled.

- Vehicle speed is approximately 3 km/h (1.9 MPH) or less
- Parking brake switch OFF

A  
B  
C  
D  
E  
F  
G  
H  
I  
J  
K  
L  
M  
O  
P

WCS

# WARNING CHIME SYSTEM

< SYSTEM DESCRIPTION >

## PARKING BRAKE RELEASE WARNING CHIME : Component Parts Location

INFOID:0000000010049228

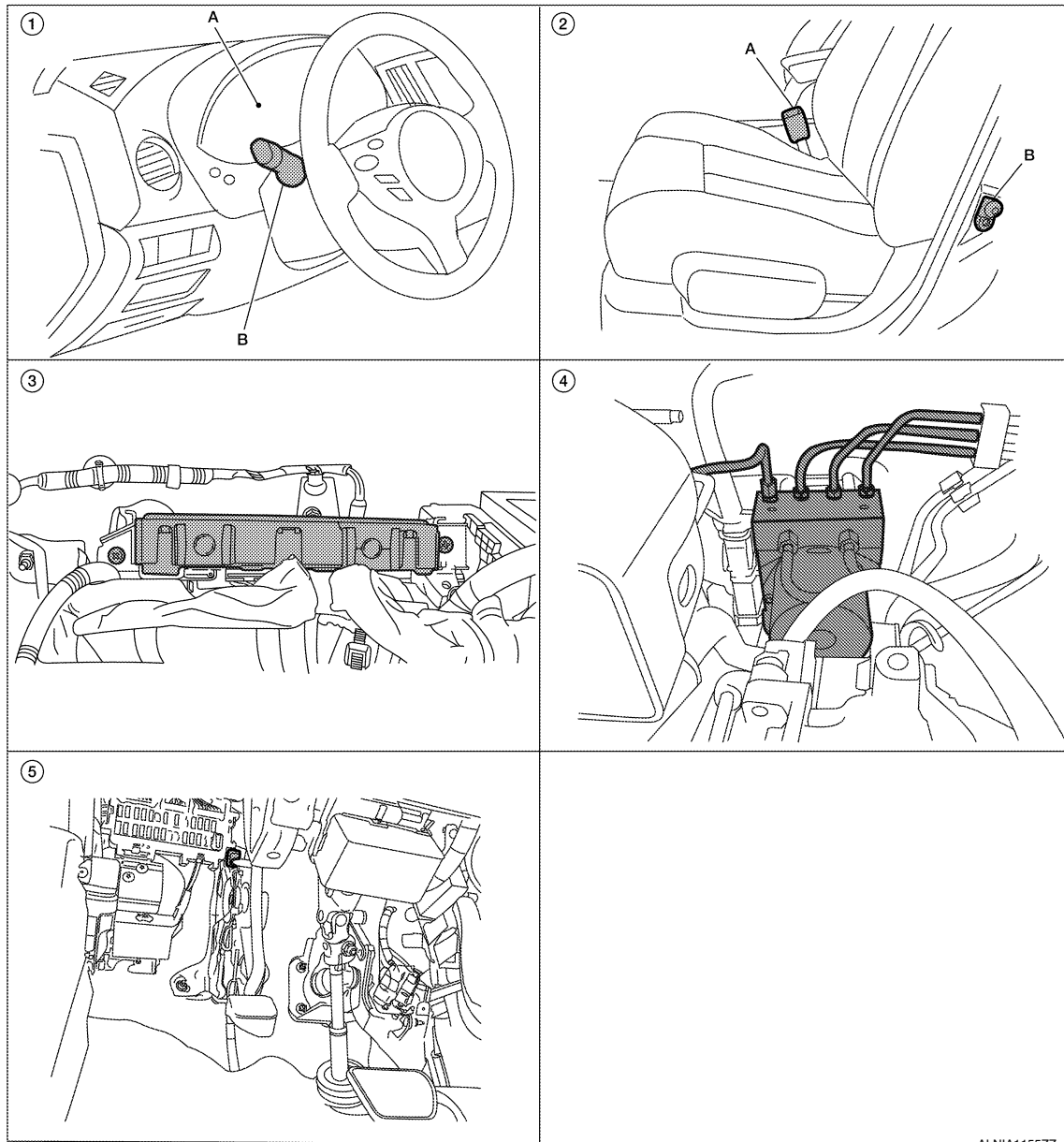

ALNIA1155ZZ

- |  |  |   |
|--|--|---|
| <p>1. A. Combination meter M24<br/>B. Combination switch (lighting and turn signal switch) M28</p> | <p>2. A. Seat belt buckle switch LH B202<br/>B. Front door switch LH B8</p>              | <p>3. BCM M16, M17, M18, M19 (view with instrument panel removed)</p> |
| <p>4. ABS actuator and electric unit (control unit) E26</p>  | <p>5. Parking brake switch E35 [view with instrument panel lower cover (LH) removed]</p> |   |

## PARKING BRAKE RELEASE WARNING CHIME : Component Description

INFOID:0000000010049229

Unit	Description
Combination meter	<ul style="list-style-type: none"> <li>Judges whether the parking brake is released using the parking brake switch signal from the parking brake switch, and sounds the buzzer if necessary.</li> <li>Receives a vehicle speed signal from ABS actuator and electric unit (control unit) via CAN communication line.</li> </ul>

# WARNING CHIME SYSTEM

## < SYSTEM DESCRIPTION >

Unit	Description
ABS actuator and electric unit (control unit)	Transmits the vehicle speed signal to combination meter via CAN communication line.
Parking brake switch	Transmits parking brake switch signal to the combination meter.

A

B

C

D

E

F

G

H

I

J

K

L

M

WCS

O

P

# DIAGNOSIS SYSTEM (METER)

< SYSTEM DESCRIPTION >

## DIAGNOSIS SYSTEM (METER)

### Diagnosis Description

INFOID:000000010054751

#### SELF-DIAGNOSIS MODE

- Odo/trip meter and information display segment operation can be checked in self-diagnosis mode.
- Meters/gauges can be checked in self-diagnosis mode.

#### OPERATION PROCEDURE

1. Turn the ignition switch OFF.
2. While pushing the odo/trip meter switch, turn the ignition switch ON again.
3. Push the odo/trip meter switch at least 3 times within 7 seconds after the ignition switch is turned ON.
4. The unified meter control unit is turned to self-diagnosis mode.
  - All the segments on the odo/trip meter illuminate.

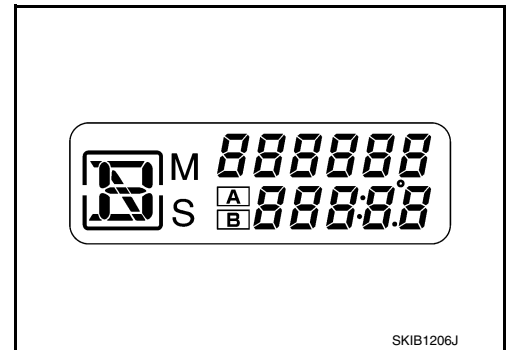

- Dots in all segments of information display LCD (1) flash alternately.

#### NOTE:

If any of the segments are not displayed, replace the combination meter. Refer to [MWI-122, "Removal and Installation"](#).

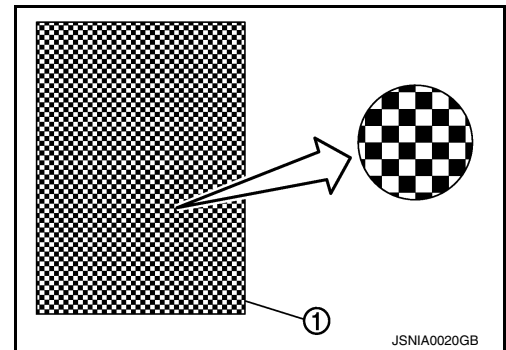

5. Push the odo/trip meter switch. Each meter/gauge should indicate as shown in the figure.

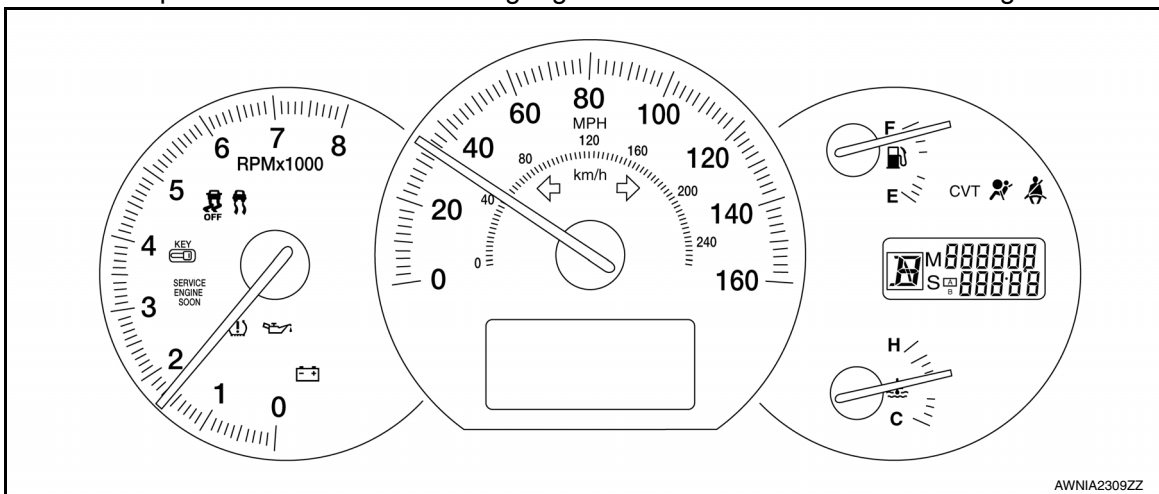

### CONSULT Function (METER/M&A)

INFOID:000000010054752

CONSULT can display each diagnostic item using the diagnostic test modes shown following.

# DIAGNOSIS SYSTEM (METER)

## < SYSTEM DESCRIPTION >

METER/M&A diagnosis mode	Description
SELF DIAGNOSTIC RESULT	Displays combination meter self-diagnosis results.
DATA MONITOR	Displays combination meter input/output data in real time.
CAN DIAG SUPPORT MNTR	The result of transmit/receive diagnosis of CAN communication can be read.

## SELF-DIAG RESULTS

Display Item List

Refer to [MWI-51, "DTC Index"](#).

## DATA MONITOR

Display Item List

X: Applicable

Display item [Unit]	MAIN SIGNALS	SELECTION FROM MENU	Description
SPEED METER [km/h] or [mph]	X	X	Displays the value of vehicle speed signal.
SPEED OUTPUT [km/h] or [mph]	X	X	Displays the value of vehicle speed signal, which is transmitted to each unit with CAN communication.
ODO OUTPUT		X	Displays the value, which is calculated by vehicle speed signal.
TACHO METER [rpm]	X	X	Displays the value of engine speed signal, which is input from ECM.
FUEL METER [lit.]	X	X	Displays the value, which processes a resistance signal from fuel gauge.
W TEMP METER [°C] or [°F]	X	X	Displays the value of engine coolant temperature signal, which is input from ECM.
ABS W/L [ON/OFF]		X	Displays [ON/OFF] condition of ABS warning lamp.
VDC/TCS IND [ON/OFF]		X	Displays [ON/OFF] condition of VDC/TCS OFF indicator lamp.
SLIP IND [ON/OFF]		X	Displays [ON/OFF] condition of SLIP indicator lamp.
BRAKE W/L [ON/OFF]		X	Displays [ON/OFF] condition of brake warning lamp.*
DOOR W/L [ON/OFF]		X	Displays [ON/OFF] condition of door warning lamp.
TRUNK/GLAS-H [ON/OFF]		X	Displays [ON/OFF] condition of trunk warning lamp.
HI-BEAM IND [ON/OFF]		X	Displays [ON/OFF] condition of high beam indicator.
TURN IND [ON/OFF]		X	Displays [ON/OFF] condition of turn indicator.
LIGHT IND [ON/OFF]		X	Displays [ON/OFF] condition of light indicator.
OIL W/L [ON/OFF]		X	Displays [ON/OFF] condition of oil pressure warning lamp.
MIL [ON/OFF]		X	Displays [ON/OFF] condition of malfunction indicator lamp.
CRUISE IND [ON/OFF]		X	Displays [ON/OFF] condition of CRUISE indicator.
CVT IND [ON/OFF]		X	Displays [ON/OFF] condition of CVT warning lamp.
FUEL W/L [ON/OFF]		X	Displays [ON/OFF] condition of low-fuel warning lamp.
WASHER W/L [ON/OFF]		X	Displays [ON/OFF] condition of low washer fluid warning lamp.
AIR PRES W/L [ON/OFF]		X	Displays [ON/OFF] condition of tire pressure warning lamp.
KEY G/Y W/L [ON/OFF]		X	Displays [ON/OFF] condition of key warning lamp.
LCD		X	Displays the value of Intelligent Key system message indication.
SHIFT IND [P, R, N, D]		X	Displays [P, R, N, D] range position of CVT.
FUEL CAP W/L [ON/OFF]		X	Status of fuel filler cap warning display detected from fuel filler cap warning display signal received from ECM via CAN communication.
M RANGE SW [ON/OFF]		X	Displays [ON/OFF] condition of manual mode range switch.
NM RANGE SW [ON/OFF]		X	Displays [ON/OFF] condition of except for manual mode range switch.
ST SFT UP SW [ON/OFF]		X	Displays [ON/OFF] condition of steering shift-up switch.

## DIAGNOSIS SYSTEM (METER)

### < SYSTEM DESCRIPTION >

Display item [Unit]	MAIN SIGNALS	SELECTION FROM MENU	Description
ST SFT DWN SW [ON/OFF]		X	Displays [ON/OFF] condition of steering shift-down switch.
AT SFT UP SW [ON/OFF]		X	Displays [ON/OFF] condition of CVT shift-up switch.
AT SFT DWN SW [ON/OFF]		X	Displays [ON/OFF] condition of CVT shift-down switch.
PKB SW [ON/OFF]		X	Displays [ON/OFF] condition of parking brake switch.
BUCKLE SW [ON/OFF]		X	Status of seat belt buckle switch LH.
BRAKE OIL SW [ON/OFF]		X	Displays [ON/OFF] condition of brake fluid level switch.
MODE A SW [ON/OFF]		X	Displays [ON/OFF] condition of mode switch A.
MODE B SW [ON/OFF]		X	Displays [ON/OFF] condition of mode switch B.
DISTANCE [km] or [mile]		X	Displays the value, which is calculated by vehicle speed signal, fuel gauge and fuel consumption from ECM.
OUTSIDE TEMP [°C]		X	Displays the ambient air temperature, which is input from ambient sensor.
FUEL LOW SIG [ON/FF]		X	Displays [ON/OFF] condition of low-fuel warning signal.
BUZZER [ON/OFF]	X	X	Displays [ON/OFF] condition of buzzer.
TPMS PRESS L [ON/FF]		X	Status of low tire pressure warning judged from low tire pressure warning lamp signal received from BCM with CAN communication line.

**NOTE:**

Some items are not available due to vehicle specification.

\*: The monitor will indicate "OFF" even though the brake warning lamp is on if either of the following conditions exist.

- The parking brake is engaged
- The brake fluid level is low



# DIAGNOSIS SYSTEM (BCM)

< SYSTEM DESCRIPTION >

## DIAGNOSIS SYSTEM (BCM)

### BUZZER

BUZZER : CONSULT Function (BCM - BUZZER)

INFOID:0000000010054753

### DATA MONITOR

Monitor Item [Unit]	Description
PUSH -SW [On/Off]	Indicates condition of push button ignition switch
UNLK SEN -DR [On/Off]	Indicates condition of door unlock sensor
VEH SPEED 1 [km/h]	Indicates vehicle speed signal received from ABS on CAN communication line
KEY SW -SLOT [On/Off]	Indicates condition of key slot
TAIL LAMP SW [On/Off]	Indicates condition of combination switch
FR FOG SW [On/Off]	Indicates condition of front fog lamp switch
DOOR SW-DR [On/Off]	Indicates condition of front door switch LH

### ACTIVE TEST

Test Item	Description
IGN KEY WARN ALM	This test is able to check key warning chime operation [On/Off].
SEAT BELT WARN TEST	This test is able to check seat belt warning chime operation [On/Off].
ID REGIST WARNING	This test is able to check ID regist warning chime operation [On/Off].
LIGHT WARN ALM	This test is able to check light warning chime operation [On/Off].

A  
B  
C  
D  
E  
F  
G  
H  
I  
J  
K  
L  
M  
O  
P

WCS

# POWER SUPPLY AND GROUND CIRCUIT

< DTC/CIRCUIT DIAGNOSIS >

## DTC/CIRCUIT DIAGNOSIS

### POWER SUPPLY AND GROUND CIRCUIT COMBINATION METER

#### COMBINATION METER : Diagnosis Procedure

INFOID:000000010054754

Regarding Wiring Diagram information, refer to [MWI-87, "Wiring Diagram"](#).

### 1. CHECK FUSES

Check for blown combination meter fuses.

Unit	Power source	Fuse No.
Combination meter	Battery	6
	Ignition switch ON or START	4

Is the inspection result normal?

YES >> GO TO 2

NO >> If fuse is blown, be sure to eliminate cause of malfunction before installing new fuse.

### 2. POWER SUPPLY CIRCUIT CHECK

1. Disconnect combination meter connector.
2. Check voltage between combination meter harness connector M24 terminals 1, 2, and ground.

Terminals		(-)	Ignition switch position		
(+)			OFF	ON	START
Connector	Terminal				
M24	1	Ground	Battery voltage	Battery voltage	Battery voltage
	2		0V	Battery voltage	Battery voltage

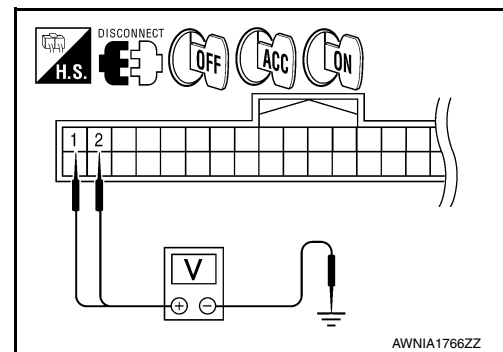

Is the inspection result normal?

YES >> GO TO 3

NO >> Check harness for open between combination meter and fuse.

### 3. GROUND CIRCUIT CHECK

1. Turn ignition switch OFF.
2. Check continuity between combination meter harness connector terminals 3, 4, 23 and ground.

Terminals		(-)	Continuity
(+)			
Connector	Terminal		
M24	3	Ground	Yes
	4		
	23		

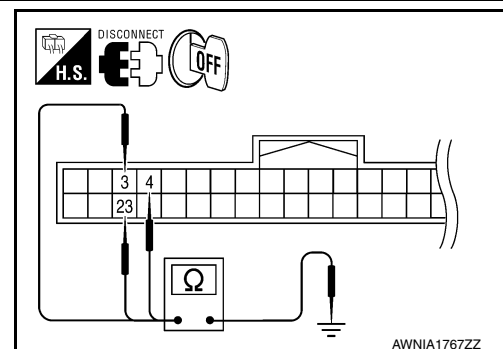

Is the inspection result normal?

YES >> Inspection End.

NO >> Repair or replace harness or connector.

### BCM (BODY CONTROL MODULE)

# POWER SUPPLY AND GROUND CIRCUIT

< DTC/CIRCUIT DIAGNOSIS >

## BCM (BODY CONTROL MODULE) : Diagnosis Procedure

INFOID:0000000110054755

Regarding Wiring Diagram information, refer to [BCS-67. "Wiring Diagram"](#).

### 1. CHECK FUSE AND FUSIBLE LINK

Check if the following BCM fuses or fusible link are blown.

Terminal No.	Signal name	Fuse and fusible link No.
1	Battery power supply	H
11		10
24		7

Is the fuse or fusible link blown?

YES >> Replace the blown fuse or fusible link after repairing the affected circuit.

NO >> GO TO 2

### 2. CHECK POWER SUPPLY CIRCUIT

1. Turn ignition switch OFF.
2. Disconnect BCM.
3. Check voltage between BCM harness connector and ground.

Terminals		Voltage (Approx.)
(+)	(-)	
BCM		Battery voltage
Connector	Terminal	
M16	1	
M17	11	
M18	24	

Is the measurement normal?

YES >> GO TO 3

NO >> Repair or replace harness.

### 3. CHECK GROUND CIRCUIT

Check continuity between BCM harness connector and ground.

BCM		Ground	Continuity
Connector	Terminal		
M17	13		Yes

Does continuity exist?

YES >> Inspection End.

NO >> Repair or replace harness.

A  
B  
C  
D  
E  
F  
G  
H  
I  
J  
K  
L  
M  
O  
P

WCS

# METER BUZZER CIRCUIT

< DTC/CIRCUIT DIAGNOSIS >

---

## METER BUZZER CIRCUIT

### Description

INFOID:000000010049235

- The buzzer for warning chime system is installed in the combination meter.
- The combination meter sounds the alarm buzzer based on the signals transmitted from various units.

### Component Function Check

INFOID:000000010049236

#### 1. CHECK OPERATION OF METER BUZZER

---

1. Select "BUZZER" of "BCM" on CONSULT.
2. Perform "LIGHT WARN ALM" of "ACTIVE TEST".

#### Does meter buzzer activate?

- YES >> Inspection End.  
NO >> Replace combination meter. Refer to [MWI-122. "Removal and Installation"](#).

### Diagnosis Procedure

INFOID:000000010049237

#### 1. CHECK POWER SUPPLY OF COMBINATION METER

---

Check power supply of combination meter. Refer to [MWI-37. "COMBINATION METER : Diagnosis Procedure"](#).

#### Is the inspection result normal?

- YES >> Inspection End.  
NO >> Repair or replace harness.

# SEAT BELT BUCKLE SWITCH SIGNAL CIRCUIT

< DTC/CIRCUIT DIAGNOSIS >

## SEAT BELT BUCKLE SWITCH SIGNAL CIRCUIT

### Description

INFOID:000000010049238

Transmits a seat belt buckle switch LH signal to the combination meter.

### Component Function Check

INFOID:000000010049239

#### 1. CHECK COMBINATION METER INPUT SIGNAL

1. Start engine.
2. Monitor seat belt warning lamp while fastening and unfastening the driver seat belt.

#### Seat belt warning lamp

When seat belt is fastened : OFF

When seat belt is unfastened : ON

Is the inspection result normal?

YES >> Inspection End.

NO >> Refer to [WCS-21, "Diagnosis Procedure"](#).

### Diagnosis Procedure

INFOID:000000010049240

Regarding Wiring Diagram information, refer to [WCS-54, "Wiring Diagram"](#).

#### 1. CHECK COMBINATION METER INPUT SIGNAL

1. Turn ignition switch ON.
2. Check voltage between combination meter harness connector M24 terminal 35 and ground.

#### 35 - Ground

When driver seat belt is fastened : Approx. 12V

When driver seat belt is unfastened : Approx. 0V

Is the inspection result normal?

YES >> Replace combination meter. Refer to [MWI-122, "Removal and Installation"](#).

NO >> GO TO 2

#### 2. CHECK SEAT BELT BUCKLE SWITCH LH CIRCUIT

1. Turn ignition switch OFF.
2. Disconnect combination meter and seat belt buckle switch LH.
3. Check continuity between combination meter harness connector M24 terminal 35 and seat belt buckle switch LH harness connector B202 terminal 1.

35 - 1 : Continuity should exist.

4. Check harness continuity between combination meter harness connector M24 terminal 35 and ground.

35 - Ground : Continuity should not exist.

Is the inspection result normal?

YES >> GO TO 3

NO >> Repair or replace harness.

#### 3. CHECK SEAT BELT BUCKLE SWITCH LH GROUND CIRCUIT

Check harness continuity between seat belt buckle switch LH harness connector B202 terminal 2 and ground.

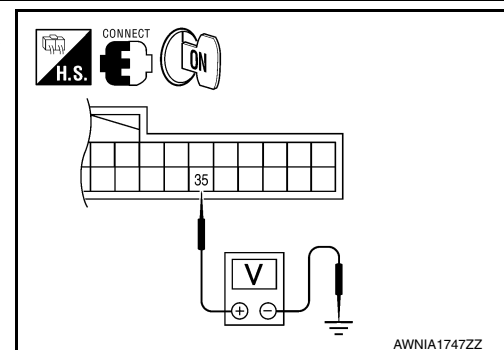

# SEAT BELT BUCKLE SWITCH SIGNAL CIRCUIT

< DTC/CIRCUIT DIAGNOSIS >

---

**2 - Ground** : **Continuity should exist.**

Is the inspection result normal?

- YES >> Inspection End.  
NO >> Repair or replace harness.

## Component Inspection

INFOID:000000010049241

### 1. CHECK SEAT BELT BUCKLE SWITCH LH

---

1. Turn ignition switch OFF.
2. Disconnect the seat belt buckle switch LH connector.
3. Check continuity between the seat belt buckle LH terminals 1 and 2.

**1- 2**

**When seat belt is fastened** : **Continuity should not exist.**

**When seat belt is unfastened** : **Continuity should exist.**

Is the inspection result normal?

- YES >> Inspection End.  
NO >> Replace the seat belt buckle switch LH. Refer to [SE-68, "Removal and Installation"](#) (with climate controlled seats) or [SE-126, "Removal and Installation"](#) (without climate controlled seats).

# COMBINATION METER

< ECU DIAGNOSIS INFORMATION >

## ECU DIAGNOSIS INFORMATION

### COMBINATION METER

Reference Value

INFOID:0000000010054772

#### VALUES ON THE DIAGNOSIS TOOL

Monitor Item	Condition	Value/Status
SPEED METER [km/h or mph]	While driving	Displays the value of the vehicle speed signal.
SPEED OUTPUT [km/h or mph]	While driving	Displays the value of the vehicle speed signal which is transmitted to each unit with CAN communication.
ODO OUTPUT [kilometers or miles]	—	Equivalent to odometer reading in combination meter
TACHO METER [rpm]	While driving	Displays the value of engine speed signal which is input from the ECM.
FUEL METER [L]	—	Displays the value processed from a resistance signal from the fuel gauge.
W TEMP METER [°C] or [°F]	—	Displays the value of the engine coolant temperature signal which is input from the ECM.
ABS W/L	ABS warning lamp ON	ON
	ABS warning lamp OFF	OFF
VDC/TCS IND	VDC OFF indicator lamp ON	ON
	VDC OFF indicator lamp OFF	OFF
SLIP IND	SLIP Indicator lamp ON	ON
	SLIP indicator lamp OFF	OFF
BRAKE W/L*	Brake warning lamp ON	ON
	Brake warning lamp OFF	OFF
DOOR W/L	Door warning lamp ON	ON
	Door warning lamp OFF	OFF
TRUNK/GLAS-H	Trunk warning lamp ON	ON
	Trunk warning lamp OFF	OFF
HI-BEAM IND	High-beam indicator lamp ON	ON
	High-beam indicator lamp OFF	OFF
TURN IND	Turn signal indicator lamp ON	ON
	Turn signal indicator lamp OFF	OFF
LIGHT IND	Light indicator lamp ON	ON
	Light indicator lamp OFF	OFF
OIL W/L	Oil pressure warning lamp ON	ON
	Oil pressure warning lamp OFF	OFF
MIL	Malfunction indicator lamp ON	ON
	Malfunction indicator lamp OFF	OFF
CRUISE IND	CRUISE indicator ON	ON
	CRUISE indicator OFF	OFF
CVT IND	CVT warning lamp ON	ON
	CVT warning lamp OFF	OFF

## COMBINATION METER

### < ECU DIAGNOSIS INFORMATION >

Monitor Item	Condition	Value/Status
FUEL W/L	Low-fuel warning lamp ON	ON
	Low-fuel warning lamp OFF	OFF
WASHER W/L	Low washer fluid warning lamp ON	ON
	Low washer fluid warning lamp OFF	OFF
AIR PRES W/L	Low tire pressure warning lamp ON	ON
	Low tire pressure warning lamp OFF	OFF
KEY G/Y W/L	Key warning lamp ON	ON
	Key warning lamp OFF	OFF
LCD	Intelligent Key information received	Displays the value of Intelligent Key system message indication.
SHIFT IND	Range position indicator P display	P
	Range position indicator R display	R
	Range position indicator N display	N
	Range position indicator D display	D
	Range position indicator L display	L
FUEL CAP W/L	—	Status of fuel filler cap warning display detected from fuel filler cap warning display signal received from ECM via CAN communication.
M RANGE SW	Manual mode range switch ON	ON
	Manual mode range switch OFF	OFF
NM RANGE SW	Except for manual mode range switch ON	ON
	Except for manual mode range switch OFF	OFF
ST SFT UP SW	Steering shift-up switch ON	ON
	Steering shift-up switch OFF	OFF
ST SFT DWN SW	Steering shift-down switch ON	ON
	Steering shift-down switch OFF	OFF
AT SFT UP SW	CVT shift-up switch ON	ON
	CVT shift-up switch OFF	OFF
AT SFT DWN SW	CVT shift-down switch ON	ON
	CVT shift-down switch OFF	OFF
PKB SW	Parking brake switch ON	ON
	Parking brake switch OFF	OFF
BUCKLE SW	—	Status of seat belt buckle switch LH.
BRAKE OIL SW	Brake fluid level switch ON	ON
	Brake fluid level switch OFF	OFF
MODE A SW	Mode A switch ON	ON
	Mode A switch OFF	OFF
MODE B SW	Mode B switch ON	ON
	Mode B switch OFF	OFF
DISTANCE [kilometers or miles]	—	Displays the value which is calculated by vehicle speed signal, fuel gauge and fuel consumption from ECM.
OUTSIDE TEMP [°C] or [°F]	—	Displays the ambient air temperature which is input from the ambient sensor.
FUEL LOW SIG	Low fuel warning displayed	ON
	Low fuel warning not displayed	OFF



# COMBINATION METER

## < ECU DIAGNOSIS INFORMATION >

Monitor Item	Condition	Value/Status
BUZZER	Buzzer ON	ON
	Buzzer OFF	OFF
TPMS PRESS L	—	Status of low tire pressure warning judged from low tire pressure warning lamp signal received from BCM with CAN communication line.

### NOTE:

\* The monitor will indicate "OFF" even though the brake warning lamp is on if either of the following conditions exist:

- The parking brake is engaged
- The brake fluid level is low

### TERMINAL LAYOUT

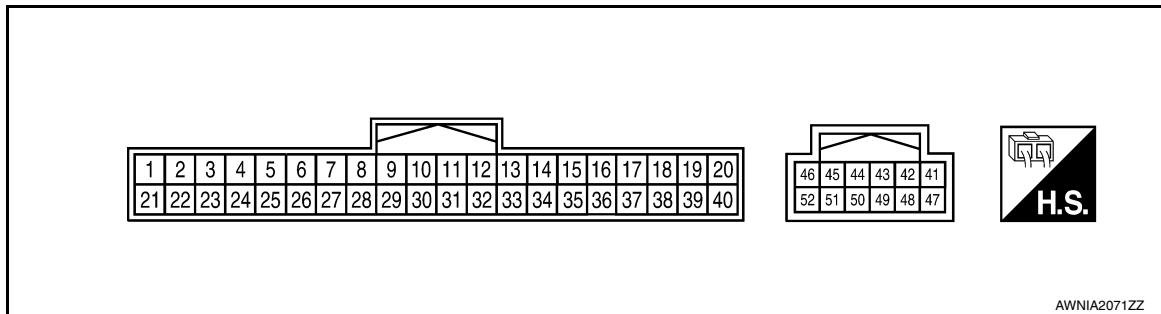

### PHYSICAL VALUES

Terminal	Wire color	Item	Condition		Reference value (V) (Approx.)
			Ignition switch	Operation or condition	
1	Y/R	Battery power supply	—	—	Battery voltage
2	O	Ignition switch ON or START	ON	—	Battery voltage
3	B	Ground (Power)	—	—	0
4	B	Ground (Illumination)			
5	B	Illumination output	—	—	Refer to <a href="#">INL-9, "System Description"</a> .
10	O/L	Mode switch ground	ON	—	0
11	L/R	Mode switch A	ON	Switch pressed	0
				Switch released	5
12	B/R	Mode switch B	ON	Switch pressed	0
				Switch released	5
15	BR/W	Air bag warning lamp input	ON	Air bag warning lamp ON	3
				Air bag warning lamp OFF	0
21	L	CAN-H	—	—	—
22	P	CAN-L	—	—	—
23	B	Ground (Circuit)	—	—	0
24	B/W	Fuel level sensor ground	ON	—	0
25	BR	Generator	ON	Generator voltage low	0
				Generator voltage normal	Battery voltage
26	G/R	Parking brake switch	ON	Parking brake depressed	0
				Parking brake released	Battery voltage
27	V	Brake fluid level switch	ON	Brake fluid level low	0
				Brake fluid level normal	Battery voltage

# COMBINATION METER

## < ECU DIAGNOSIS INFORMATION >

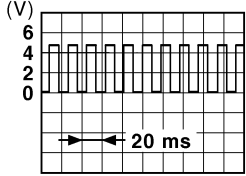
Terminal	Wire color	Item	Condition		Reference value (V) (Approx.)
			Ignition switch	Operation or condition	
28	L/O	Security indicator input	OFF	Security indicator ON	0
				Security indicator OFF	Battery voltage
29	R	Washer fluid level switch	ON	Washer fluid level low	0
				Washer fluid level normal	Battery voltage
30	L/B	Vehicle speed signal output (2-pulse)	ON	Speedometer operated [When vehicle speed is approx. 20 km/h (12 MPH)]	240 Hz
31	V/W	Vehicle speed signal output (8-pulse)	ON	Speedometer operated [When vehicle speed is approx. 40 km/h (25 MPH)]	<p><b>NOTE:</b> Maximum voltage may be 12V due to specifications (connected units).</p>  <p style="text-align: right; font-size: small;">PKIC0643E</p>
34	G/B	Fuel level sensor signal	—	—	Refer to <a href="#">MWI-15, "FUEL GAUGE : System Description"</a> .
35	W/B	Seat belt buckle switch LH	ON	Unfastened (ON)	0
				Fastened (OFF)	Battery voltage
36	L/W	Seat belt buckle switch RH	ON	Unfastened (ON)	0
				Fastened (OFF)	Battery voltage
37	G	Not M range	ON	Manual mode switch OFF	0
				Manual mode switch ON	Battery voltage
38	BR	CVT shift down	ON	<ul style="list-style-type: none"> <li>• Manual mode switch ON</li> <li>• Shift down operation</li> </ul>	0
				Other than above	Battery voltage
39	W	CVT shift up	ON	<ul style="list-style-type: none"> <li>• Manual mode switch ON</li> <li>• Shift up operation</li> </ul>	0
				Other than above	Battery voltage
40	LG/R	M range	ON	Manual mode switch OFF	Battery voltage
				Manual mode switch ON	0
49	G	Paddle shifter signal (shift down)	ON	Shift down operation	0
				Switch released	Battery voltage
50	O	Paddle shifter signal (shift up)	ON	Shift up operation	0
				Switch released	Battery voltage

### Fail Safe

INFOID:0000000010054773

The combination meter performs a fail-safe operation for the functions listed below when communication is lost.

Function	Specifications	
Speedometer	Zero indication.	
Tachometer		
Fuel gauge		
Engine coolant temperature gauge		
Illumination control	Meter illumination	Change to nighttime mode when communication is lost.

# COMBINATION METER

## < ECU DIAGNOSIS INFORMATION >

Function		Specifications	
Segment LCD	Odometer	Freeze current indication.	A
	CVT position	Display turns off.	
Buzzer		Buzzer turns off.	B
Warning lamp/indicator lamp	ABS warning lamp	Lamp turns on when communication is lost.	C
	Brake warning lamp		
	TCS/VDC OFF indicator lamp		
	SLIP indicator lamp		
	Malfunction indicator lamp		D
	CVT warning lamp	Lamp turns off when communication is lost.	E
	Oil pressure warning lamp		
	Master warning lamp		
	Air bag warning lamp		
	High beam indicator		F
	Turn signal indicator lamp		
	CRUISE indicator lamp		
	Intelligent Key system warning lamp		G
	Driver and passenger seat belt warning lamp	Lamp turns off when disconnected.	H
	Charge warning lamp		
Security indicator lamp			
Low tire pressure warning lamp	Lamp will flash every second for 1 minute and then stay on continuously thereafter.	I	

## DTC Index

INFOID:000000010054774

CONSULT display	Malfunction	Reference page	
CAN COMM CIRCUIT [U1000]	When combination meter is not transmitting or receiving CAN communication signal for 2 seconds or more.	<a href="#">MWI-32</a>	J
CONTROL UNIT (CAN) [U1010]	When detecting error during the initial diagnosis of the CAN controller of combination meter.	<a href="#">MWI-33</a>	K
VEHICLE SPEED [B2205]	The abnormal vehicle speed signal is input from the ABS actuator and electric unit (control unit) for 2 seconds or more.	<a href="#">MWI-34</a>	L
ENGINE SPEED [B2267]	If ECM continuously transmits abnormal engine speed signals for 2 seconds or more.	<a href="#">MWI-35</a>	M
WATER TEMP [B2268]	If ECM continuously transmits abnormal engine coolant temperature signals for 60 seconds or more.	<a href="#">MWI-36</a>	WCS

### NOTE:

"TIME" indicates the following.

- 0: Indicates that a malfunction is detected at present.
- 1-63: Indicates that a malfunction was detected in the past. (Displays number of ignition switch OFF → ON cycles after malfunction is detected. Self-diagnosis result is erased when "63" is exceeded.)

# BCM (BODY CONTROL MODULE)

< ECU DIAGNOSIS INFORMATION >

## BCM (BODY CONTROL MODULE)

### Reference Value

INFOID:000000010054775

#### NOTE:

The Signal Tech II Tool (J-50190) can be used to perform the following functions. Refer to the Signal Tech II User Guide for additional information.

- Activate and display TPMS transmitter IDs
- Display tire pressure reported by the TPMS transmitter
- Read TPMS DTCs
- Register TPMS transmitter IDs
- Check Intelligent Key relative signal strength
- Confirm vehicle Intelligent Key antenna signal strength

### VALUES ON THE DIAGNOSIS TOOL

Monitor Item	Condition	Value/Status
FR WIPER HI	Other than front wiper switch HI	OFF
	Front wiper switch HI	ON
FR WIPER LOW	Other than front wiper switch LO	OFF
	Front wiper switch LO	ON
FR WASHER SW	Front washer switch OFF	OFF
	Front washer switch ON	ON
FR WIPER INT	Other than front wiper switch INT	OFF
	Front wiper switch INT	ON
FR WIPER STOP	Front wiper is not in STOP position	OFF
	Front wiper is in STOP position	ON
INT VOLUME	Wiper intermittent dial is in a dial position 1 - 7	Wiper intermittent dial position
TURN SIGNAL R	Other than turn signal switch RH	OFF
	Turn signal switch RH	ON
TURN SIGNAL L	Other than turn signal switch LH	OFF
	Turn signal switch LH	ON
TAIL LAMP SW	Other than lighting switch 1ST and 2ND	OFF
	Lighting switch 1ST or 2ND	ON
HI BEAM SW	Other than lighting switch HI	OFF
	Lighting switch HI	ON
HEAD LAMP SW 1	Other than lighting switch 2ND	OFF
	Lighting switch 2ND	ON
HEAD LAMP SW 2	Other than lighting switch 2ND	OFF
	Lighting switch 2ND	ON
PASSING SW	Other than lighting switch PASS	OFF
	Lighting switch PASS	ON
AUTO LIGHT SW	Other than lighting switch AUTO	OFF
	Lighting switch AUTO	ON
FR FOG SW	Front fog lamp switch OFF	OFF
	Front fog lamp switch ON	ON
DOOR SW-DR	Driver door closed	OFF
	Driver door opened	ON
DOOR SW-AS	Passenger door closed	OFF
	Passenger door opened	ON

## BCM (BODY CONTROL MODULE)

### < ECU DIAGNOSIS INFORMATION >

Monitor Item	Condition	Value/Status	
DOOR SW-RR	Rear door RH closed	OFF	A
	Rear door RH opened	ON	
DOOR SW-RL	Rear door LH closed	OFF	B
	Rear door LH opened	ON	
DOOR SW-BK	Trunk door closed	OFF	C
	Trunk door opened	ON	
CDL LOCK SW	Other than power door lock switch LOCK	OFF	D
	Power door lock switch LOCK	ON	
CDL UNLOCK SW	Other than power door lock switch UNLOCK	OFF	E
	Power door lock switch UNLOCK	ON	
KEY CYL LK-SW	Other than driver door key cylinder LOCK position	OFF	F
	Driver door key cylinder LOCK position	ON	
KEY CYL UN-SW	Other than driver door key cylinder UNLOCK position	OFF	G
	Driver door key cylinder UNLOCK position	ON	
HAZARD SW	When hazard switch is not pressed	OFF	H
	When hazard switch is pressed	ON	
REAR DEF SW	When rear window defogger switch is pressed	ON	I
TR CANCEL SW	Trunk lid opener cancel switch OFF	OFF	J
	Trunk lid opener cancel switch ON	ON	
TR/BD OPEN SW	Trunk lid opener switch OFF	OFF	K
	While the trunk lid opener switch is turned ON	ON	
TRNK/HAT MNTR	Trunk lid closed	OFF	L
	Trunk lid opened	ON	
RKE-LOCK	When LOCK button of Intelligent Key is not pressed	OFF	M
	When LOCK button of Intelligent Key is pressed	ON	
RKE-UNLOCK	When UNLOCK button of Intelligent Key is not pressed	OFF	WCS
	When UNLOCK button of Intelligent Key is pressed	ON	
RKE-TR/BD	When TRUNK OPEN button of Intelligent Key is not pressed	OFF	O
	When TRUNK OPEN button of Intelligent Key is pressed	ON	
RKE-PANIC	When PANIC button of Intelligent Key is not pressed	OFF	P
	When PANIC button of Intelligent Key is pressed	ON	
RKE-P/W OPEN	When UNLOCK button of Intelligent Key is not pressed and held	OFF	
	When UNLOCK button of Intelligent Key is pressed and held	ON	
RKE-MODE CHG	When LOCK/UNLOCK button of Intelligent Key is not pressed and held simultaneously	OFF	
	When LOCK/UNLOCK button of Intelligent Key is pressed and held simultaneously	ON	
OPTICAL SENSOR	When outside of the vehicle is bright	Close to 5 V	
	When outside of the vehicle is dark	Close to 0 V	
REQ SW -DR	When front door request switch is not pressed (driver side)	OFF	
	When front door request switch is pressed (driver side)	ON	
REQ SW -AS	When front door request switch is not pressed (passenger side)	OFF	
	When front door request switch is pressed (passenger side)	ON	
REQ SW -RL	When rear door request switch is not pressed (driver side)	OFF	
	When rear door request switch is pressed (driver side)	ON	

## BCM (BODY CONTROL MODULE)

### < ECU DIAGNOSIS INFORMATION >

Monitor Item	Condition	Value/Status
REQ SW -RR	When rear door request switch is not pressed (passenger side)	OFF
	When rear door request switch is pressed (passenger side)	ON
REQ SW -BD/TR	When trunk opener request switch is not pressed	OFF
	When trunk opener request switch is pressed	ON
PUSH SW	When engine switch (push switch) is not pressed	OFF
	When engine switch (push switch) is pressed	ON
IGN RLY2 -F/B	Ignition switch OFF or ACC	OFF
	Ignition switch ON	ON
ACC RLY -F/B	Ignition switch OFF	OFF
	Ignition switch ACC or ON	ON
BRAKE SW 1	When the brake pedal is not depressed	ON
	When the brake pedal is depressed	OFF
DETE/CANCL SW	When selector lever is in P position	OFF
	When selector lever is in any position other than P	ON
SFT PN/N SW	When selector lever is in any position other than P or N	OFF
	When selector lever is in P or N position	ON
UNLK SEN -DR	Driver door UNLOCK status	OFF
	Driver door LOCK status	ON
PUSH SW -IPDM	When engine switch (push switch) is not pressed	OFF
	When engine switch (push switch) is pressed	ON
IGN RLY1 -F/B	Ignition switch OFF or ACC	OFF
	Ignition switch ON	ON
DETE SW -IPDM	When selector lever is in P position	OFF
	When selector lever is in any position other than P	ON
SFT PN -IPDM	When selector lever is in any position other than P or N	OFF
	When selector lever is in P or N position	ON
SFT P -MET	When selector lever is in any position other than P	OFF
	When selector lever is in P position	ON
SFT N -MET	When selector lever is in any position other than N	OFF
	When selector lever is in N position	ON
ENGINE STATE	Engine stopped	STOP
	While the engine stalls	STALL
	At engine cranking	CRANK
	Engine running	RUN
VEH SPEED 1	While driving	Equivalent to speedometer reading
VEH SPEED 2	While driving	Equivalent to speedometer reading
DOOR STAT-DR	Driver door LOCK status	LOCK
	Wait with selective UNLOCK operation (5 seconds)	READY
	Driver door UNLOCK status	UNLK
DOOR STAT-AS	Passenger door LOCK status	LOCK
	Wait with selective UNLOCK operation (5 seconds)	READY
	Passenger door UNLOCK status	UNLK
ID OK FLAG	Ignition switch ACC or ON	RESET
	Ignition switch OFF	SET

## BCM (BODY CONTROL MODULE)

### < ECU DIAGNOSIS INFORMATION >

Monitor Item	Condition	Value/Status	
PRMT ENG STRT	When the engine start is prohibited	RESET	A
	When the engine start is permitted	SET	
KEY SW -SLOT	When Intelligent Key is not inserted into key slot	OFF	B
	When Intelligent Key is inserted into key slot	ON	
RKE OPE COUN1	During the operation of Intelligent Key	Operation frequency of Intelligent Key	
CONFIRM ID ALL	The key ID that the key slot receives does not accord with any key ID registered to BCM.	YET	C
	The key ID that the key slot receives accords with any key ID registered to BCM.	DONE	D
CONFIRM ID4	The key ID that the key slot receives does not accord with the fourth key ID registered to BCM.	YET	E
	The key ID that the key slot receives accords with the fourth key ID registered to BCM.	DONE	
CONFIRM ID3	The key ID that the key slot receives does not accord with the third key ID registered to BCM.	YET	F
	The key ID that the key slot receives accords with the third key ID registered to BCM.	DONE	
CONFIRM ID2	The key ID that the key slot receives does not accord with the second key ID registered to BCM.	YET	G
	The key ID that the key slot receives accords with the second key ID registered to BCM.	DONE	H
CONFIRM ID1	The key ID that the key slot receives does not accord with the first key ID registered to BCM.	YET	I
	The key ID that the key slot receives accords with the first key ID registered to BCM.	DONE	
TP 4	The ID of fourth key is not registered to BCM	YET	J
	The ID of fourth key is registered to BCM	DONE	
TP 3	The ID of third key is not registered to BCM	YET	K
	The ID of third key is registered to BCM	DONE	
TP 2	The ID of second key is not registered to BCM	YET	L
	The ID of second key is registered to BCM	DONE	
TP 1	The ID of first key is not registered to BCM	YET	M
	The ID of first key is registered to BCM	DONE	
AIR PRESS FL	Ignition switch ON (only when the signal from the transmitter is received)	Air pressure of front LH tire	
AIR PRESS FR	Ignition switch ON (only when the signal from the transmitter is received)	Air pressure of front RH tire	
AIR PRESS RR	Ignition switch ON (only when the signal from the transmitter is received)	Air pressure of rear RH tire	WCS
AIR PRESS RL	Ignition switch ON (only when the signal from the transmitter is received)	Air pressure of rear LH tire	O
ID REGST FL1	When ID of front LH tire transmitter is registered	DONE	P
	When ID of front LH tire transmitter is not registered	YET	
ID REGST FR1	When ID of front RH tire transmitter is registered	DONE	
	When ID of front RH tire transmitter is not registered	YET	
ID REGST RR1	When ID of rear RH tire transmitter is registered	DONE	
	When ID of rear RH tire transmitter is not registered	YET	
ID REGST RL1	When ID of rear LH tire transmitter is registered	DONE	
	When ID of rear LH tire transmitter is not registered	YET	

## BCM (BODY CONTROL MODULE)

### < ECU DIAGNOSIS INFORMATION >

Monitor Item	Condition	Value/Status
WARNING LAMP	Tire pressure indicator OFF	OFF
	Tire pressure indicator ON	ON
BUZZER	Tire pressure warning alarm is not sounding	OFF
	Tire pressure warning alarm is sounding	ON



# BCM (BODY CONTROL MODULE)

< ECU DIAGNOSIS INFORMATION >

## Terminal Layout

INFOID:000000010054776

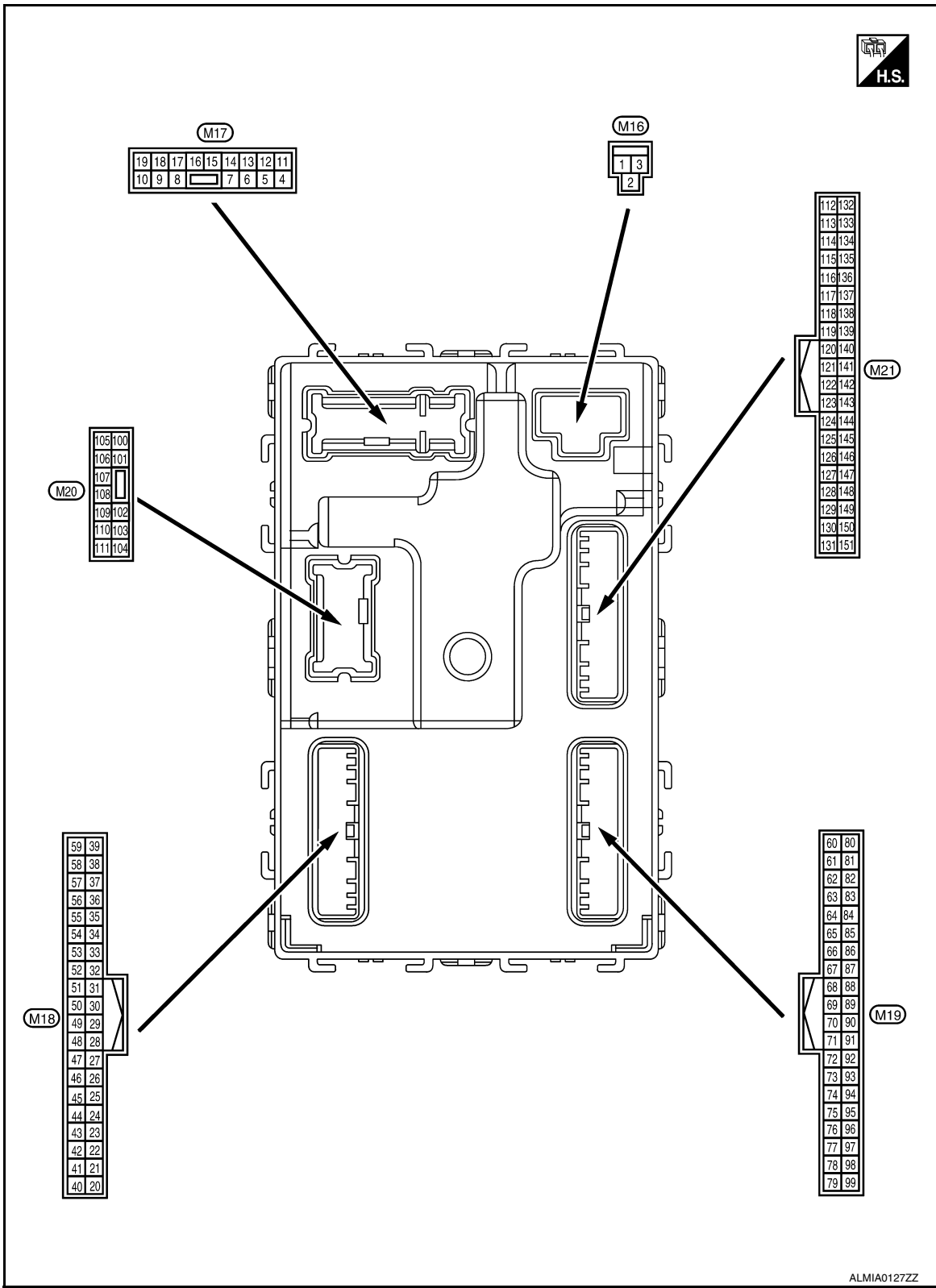

A  
B  
C  
D  
E  
F  
G  
H  
I  
J  
K  
L  
M  
WCS  
O  
P

## Physical Values

INFOID:000000010054777

# BCM (BODY CONTROL MODULE)

## < ECU DIAGNOSIS INFORMATION >

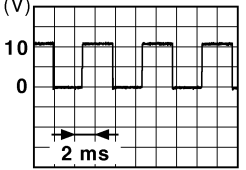
Terminal No. (Wire color)		Description		Condition		Value (Approx.)
		Signal name	Input/ Output			
(+)	(-)					
1 (W/B)	Ground	Battery power supply	Input	Ignition switch OFF		Battery voltage
2 (R/Y)	Ground	Battery power supply output	Output	Ignition switch OFF		Battery voltage
3 (L/W)	Ground	Ignition power supply output	Output	Ignition switch ON		Battery voltage
4 (P/W)	Ground	Interior room lamp power supply	Output	After passing the interior room lamp battery saver operation time		0V
				Any other time after passing the interior room lamp battery saver operation time		Battery voltage
5 (G)	Ground	Front door RH UNLOCK	Output	Front door RH	UNLOCK (actuator is activated)	Battery voltage
					Other than UNLOCK (actuator is not activated)	0V
7 (R/W)	Ground	Step lamp	Output	Step lamp	ON	0V
					OFF	Battery voltage
8 (V)	Ground	All doors LOCK	Output	All doors	LOCK (actuator is activated)	Battery voltage
					Other than LOCK (actuator is not activated)	0V
9 (L)	Ground	Front door LH UNLOCK	Output	Front door LH	UNLOCK (actuator is activated)	Battery voltage
					Other than UNLOCK (actuator is not activated)	0V
10 (G)	Ground	Rear door RH and rear door LH UNLOCK	Output	Rear door RH and rear door LH	UNLOCK (actuator is activated)	Battery voltage
					Other than UNLOCK (actuator is not activated)	0V
11 (Y/R)	Ground	Battery power supply	Input	Ignition switch OFF		Battery voltage
13 (B)	Ground	Ground	—	Ignition switch ON		0V
14 (GR/W)	Ground	Engine switch (push switch) illumination ground	Input	Tail lamp	OFF	0V
					ON	<b>NOTE:</b> When the illumination brightening/dimming level is in the neutral position 
15 (Y/L)	Ground	ACC indicator lamp	Output	Ignition switch	OFF	Battery voltage
					ACC or ON	0V

JSNIA0010GB

# BCM (BODY CONTROL MODULE)

## < ECU DIAGNOSIS INFORMATION >

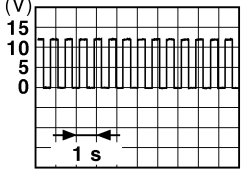
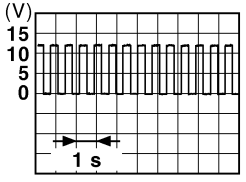
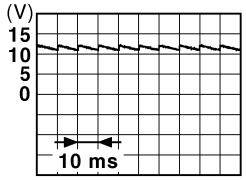

Terminal No. (Wire color)		Description		Condition		Value (Approx.)
(+)	(-)	Signal name	Input/ Output			
17 (G/B)	Ground	Turn signal (RH)	Output	Ignition switch ON	Turn signal switch OFF	0V
					Turn signal switch RH	 <p style="text-align: center;">6.5 V</p>
18 (G/Y)	Ground	Turn signal (LH)	Output	Ignition switch ON	Turn signal switch OFF	0V
					Turn signal switch LH	 <p style="text-align: center;">6.5 V</p>
19 (Y)	Ground	Room lamp timer control	Output	Interior room lamp	OFF	Battery voltage
					ON	0V
21 (P/B)	Ground	Optical sensor signal	Input	Ignition switch ON	When outside of the vehi- cle is bright	Close to 5V
					When outside of the vehi- cle is dark	Close to 0V
24 (R/W)	Ground	Stop lamp switch 1	Input	—	Battery voltage	
26 (O/L)	Ground	Stop lamp switch 2	Input	Stop lamp switch	OFF (brake pedal is re- leased)	0V
					ON (brake pedal is de- pressed)	Battery voltage
27 (O)	Ground	Front door lock as- sembly LH (unlock sensor)	Input	Front door LH	LOCK status	 <p style="text-align: center;">11.8V</p>
					UNLOCK status	0V
29 (Y)	Ground	Key slot switch	Input	When Intelligent Key is inserted into key slot	Battery voltage	
				When Intelligent Key is not inserted into key slot	0V	
31 (G)	Ground	Rear window defog- ger feedback signal	Input	Rear window de- fogger switch	OFF	0V
				ON	Battery voltage	

A  
B  
C  
D  
E  
F  
G  
H  
I  
J  
K  
L  
M  
N  
O  
P

WCS

# BCM (BODY CONTROL MODULE)

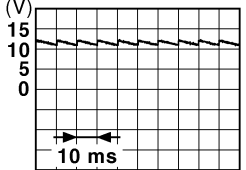
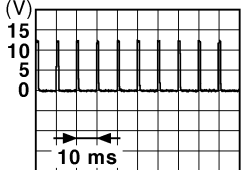
## < ECU DIAGNOSIS INFORMATION >

Terminal No. (Wire color)		Description		Condition		Value (Approx.)
(+)	(-)	Signal name	Input/ Output			
32 (R/B)	Ground	Front door RH switch	Input	Front door RH switch	OFF (when front door RH closes)	 <p style="text-align: right; font-size: small;">JPMA0011GB</p> <p style="text-align: center;">11.8 V</p>
					ON (when front door RH opens)	0V
37 (O)	Ground	Trunk lid opener cancel switch	Input	Trunk lid opener cancel switch	CANCEL	 <p style="text-align: right; font-size: small;">JPMA0012GB</p> <p style="text-align: center;">1.1V</p>
					ON	0V
38 (GR/W)	Ground	Rear window defogger ON signal	Input	Rear window defogger switch	OFF	5V
					ON	0V
40 (Y/G)	Ground	Power window serial link	Input/ Output	Ignition switch ON	 <p style="text-align: right; font-size: small;">JPMA0013GB</p> <p style="text-align: center;">10.2V</p>	
				Ignition switch OFF or ACC	0V	
41 (W)	Ground	Engine switch (push switch) illumination	Output	Engine switch (push switch) illumination	ON	5.5V
					OFF	0V
42 (R)	Ground	LOCK indicator lamp	Output	LOCK indicator lamp	ON	0V
					OFF	Battery voltage
45 (P)	Ground	Receiver & sensor ground	Input	Ignition switch ON		0V
46 (V/W)	Ground	Receiver & sensor power supply output	Output	Ignition switch	OFF	0V
					ACC or ON	5.0V

# BCM (BODY CONTROL MODULE)

## < ECU DIAGNOSIS INFORMATION >

Terminal No. (Wire color)		Description		Condition	Value (Approx.)	
(+)	(-)	Signal name	Input/ Output			
47 (G/O)	Ground	Tire pressure receiver signal	Input/ Output	Ignition switch ON	<p style="text-align: right;">OCC3881D</p>	
				When receiving the signal from the transmitter	<p style="text-align: right;">OCC3880D</p>	
48 (R/G)	Ground	Selector lever transmission range switch signal	Input	Selector lever	P or N position 12.0V	
					Except P and N positions 0V	
49 (L/O)	Ground	Security indicator signal	Output	Security indicator	ON 0V	
				Blinking	<p style="text-align: right;">JPMA0014GB</p> <p style="text-align: center;">11.3V</p>	
50 (LG/B)	Ground	Combination switch OUTPUT 5	Input	Combination switch (Wiper intermittent dial 4)	All switch OFF 0V	
					Lighting switch 1ST	<p style="text-align: right;">JPMA0031GB</p> <p style="text-align: center;">10.7V</p>
					Lighting switch high-beam	
					Lighting switch 2ND	
	Turn signal switch RH					
51 (L/W)	Ground	Combination switch OUTPUT 1	Input	Combination switch	All switch OFF (Wiper intermittent dial 4) 0V	
					Front wiper switch HI (Wiper intermittent dial 4)	<p style="text-align: right;">JPMA0032GB</p> <p style="text-align: center;">10.7V</p>
				Any of the conditions below with all switch OFF	<ul style="list-style-type: none"> <li>• Wiper intermittent dial 1</li> <li>• Wiper intermittent dial 2</li> <li>• Wiper intermittent dial 3</li> <li>• Wiper intermittent dial 6</li> <li>• Wiper intermittent dial 7</li> </ul>	

A  
B  
C  
D  
E  
F  
G  
H  
I  
J  
K  
L  
M  
O  
P

WCS

# BCM (BODY CONTROL MODULE)

## < ECU DIAGNOSIS INFORMATION >

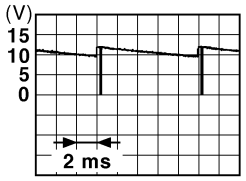
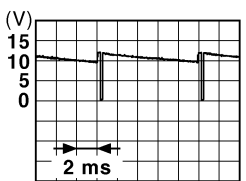
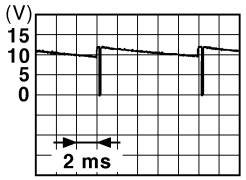
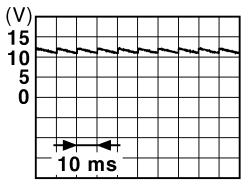
Terminal No. (Wire color)		Description		Condition	Value (Approx.)	
(+)	(-)	Signal name	Input/ Output			
52 (G/B)	Ground	Combination switch OUTPUT 2	Input	Combination switch	All switch OFF (Wiper intermittent dial 4)	0V
					Front washer switch ON (Wiper intermittent dial 4)	
					Any of the conditions below with all switch OFF	
					<ul style="list-style-type: none"> <li>• Wiper intermittent dial 1</li> <li>• Wiper intermittent dial 5</li> <li>• Wiper intermittent dial 6</li> </ul>	
					10.7V	
53 (LG/ R)	Ground	Combination switch OUTPUT 3	Input	Combination switch (Wiper intermit- tent dial 4)	All switch OFF	0V
					Front wiper switch INT	
					Front wiper switch LO	
					Lighting switch AUTO	
					10.7V	
54 (G/Y)	Ground	Combination switch OUTPUT 4	Input	Combination switch (Wiper intermit- tent dial 4)	All switch OFF	0V
					Front fog lamp switch ON	
					Lighting switch 2ND	
					Lighting switch flash-to- pass	
					10.7V	
57 (W)	Ground	Tire pressure warn- ing check switch	Input	—	5V	
58 (SB)	Ground	Front door LH switch	Input	Front door LH switch	OFF (front door LH CLOSE)	
					ON (front door LH OPEN)	
59 (G/R)	Ground	Rear window defog- ger relay	Output	Rear window de- fogger	Active	Battery voltage
					Not activated	0V

# BCM (BODY CONTROL MODULE)

## < ECU DIAGNOSIS INFORMATION >

Terminal No. (Wire color)		Description		Condition	Value (Approx.)
(+)	(-)	Signal name	Input/ Output		
60 (B/R)	Ground	Front console antenna 2 (-)	Output	Ignition switch OFF	<p style="text-align: right; font-size: small;">JMKIA0062GB</p>
				When Intelligent Key is not in the passenger compartment	<p style="text-align: right; font-size: small;">JMKIA0063GB</p>
61 (W/R)	Ground	Center console antenna 2 (+)	Output	Ignition switch OFF	<p style="text-align: right; font-size: small;">JMKIA0062GB</p>
				When Intelligent Key is not in the passenger compartment	<p style="text-align: right; font-size: small;">JMKIA0063GB</p>
62 (V)	Ground	Front outside handle RH antenna (-)	Output	When the front door RH request switch is operated with ignition switch OFF	<p style="text-align: right; font-size: small;">JMKIA0062GB</p>
				When Intelligent Key is not in the antenna detection area	<p style="text-align: right; font-size: small;">JMKIA0063GB</p>

A  
B  
C  
D  
E  
F  
G  
H  
I  
J  
K  
L  
M  
O  
P

WCS

# BCM (BODY CONTROL MODULE)

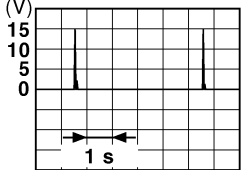
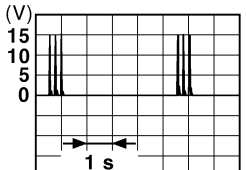
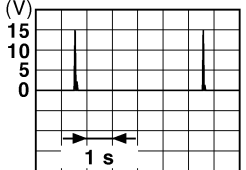
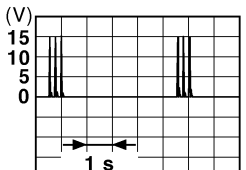
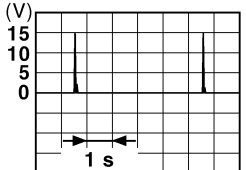
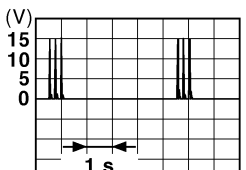

## < ECU DIAGNOSIS INFORMATION >

Terminal No. (Wire color)		Description		Condition	Value (Approx.)
(+)	(-)	Signal name	Input/ Output		
63 (P)	Ground	Front outside handle RH antenna (+)	Output	When the front door RH request switch is operated with ignition switch OFF	 <p style="text-align: right; font-size: small;">JMKIA0062GB</p>
				When Intelligent Key is not in the antenna detection area	 <p style="text-align: right; font-size: small;">JMKIA0063GB</p>
64 (V)	Ground	Front outside handle LH antenna (-)	Output	When the front door LH request switch is operated with ignition switch OFF	 <p style="text-align: right; font-size: small;">JMKIA0062GB</p>
				When Intelligent Key is not in the antenna detection area	 <p style="text-align: right; font-size: small;">JMKIA0063GB</p>
65 (P)	Ground	Front outside handle LH antenna (+)	Output	When the front door LH request switch is operated with ignition switch OFF	 <p style="text-align: right; font-size: small;">JMKIA0062GB</p>
				When Intelligent Key is not in the antenna detection area	 <p style="text-align: right; font-size: small;">JMKIA0063GB</p>

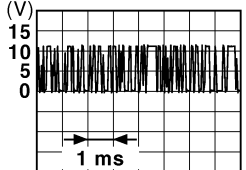
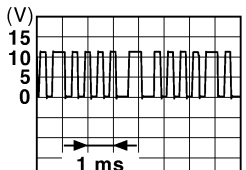
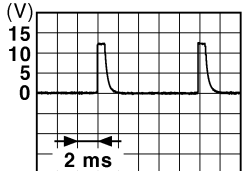

# BCM (BODY CONTROL MODULE)

## < ECU DIAGNOSIS INFORMATION >

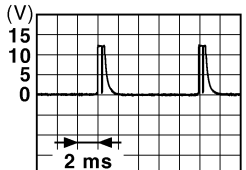

Terminal No. (Wire color)		Description		Condition		Value (Approx.)
(+)	(-)	Signal name	Input/ Output			
68 (G/O)	Ground	NATS antenna amp (built in key slot)	Input/ Output	During waiting	Ignition switch is pressed while inserting the Intelli- gent Key into the key slot.	Just after pressing ignition switch. Pointer of tester should move.
69 (O)	Ground	NATS antenna amp (built in key slot)	Input/ Output	During waiting	Ignition switch is pressed while inserting the Intelli- gent Key into the key slot.	Just after pressing ignition switch. Pointer of tester should move.
70 (R/B)	Ground	Ignition relay-2 con- trol	Output	Ignition switch	OFF or ACC	0V
					ON	Battery voltage
71 (L/O)	Ground	Remote keyless entry receiver signal	Input/ Output	During waiting		 <p style="text-align: right; font-size: small;">JMKIA0064GB</p>
				When operating either button on Intelligent Key		 <p style="text-align: right; font-size: small;">JMKIA0065GB</p>
75 (R/Y)	Ground	Combination switch INPUT 5	Output	Combination switch	All switch OFF (Wiper intermittent dial 4)	 <p style="text-align: right; font-size: small;">JPMIA0041GB</p> <p style="text-align: center;">1.4V</p>
					Front fog lamp switch ON (Wiper intermittent dial 4)	 <p style="text-align: right; font-size: small;">JPMIA0037GB</p> <p style="text-align: center;">1.3V</p>
					Any of the conditions below with all switch OFF • Wiper intermittent dial 1 • Wiper intermittent dial 2 • Wiper intermittent dial 6 • Wiper intermittent dial 7	 <p style="text-align: right; font-size: small;">JPMIA0040GB</p> <p style="text-align: center;">1.3V</p>

A  
B  
C  
D  
E  
F  
G  
H  
I  
J  
K  
L  
M  
O  
P

WCS

# BCM (BODY CONTROL MODULE)

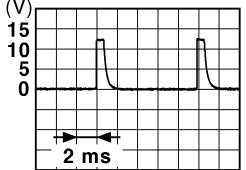
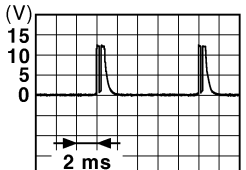
## < ECU DIAGNOSIS INFORMATION >

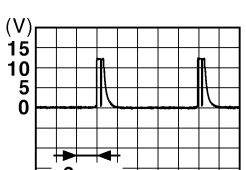
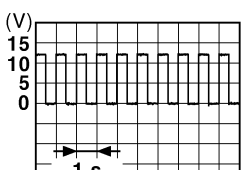
Terminal No. (Wire color)		Description		Condition	Value (Approx.)
(+)	(-)	Signal name	Input/ Output		
76 (R/G)	Ground	Combination switch INPUT 3	Output	Combination switch	All switch OFF (Wiper intermittent dial 4)  JPMIA0041GB 1.4V
					Lighting switch high-beam (Wiper intermittent dial 4)  JPMIA0036GB 1.3V
					Lighting switch 2ND (Wiper intermittent dial 4)  JPMIA0037GB 1.3V
					Any of the conditions below with all switch OFF • Wiper intermittent dial 1 • Wiper intermittent dial 2 • Wiper intermittent dial 3  JPMIA0040GB 1.3V
78 (P)	Ground	CAN-L	Input/ Output	—	—
79 (L)	Ground	CAN-H	Input/ Output	—	—
80 (R/L)	Ground	Key slot illumination	Output	Key slot illumina- tion	OFF Battery voltage
					Blinking  JPMIA0015GB 6.5V
81 (LG)	Ground	ON indicator lamp	Output	Ignition switch	ON 0V
					OFF or ACC 0V
					ON Battery voltage

# BCM (BODY CONTROL MODULE)

## < ECU DIAGNOSIS INFORMATION >

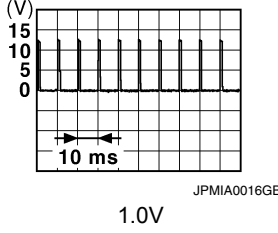
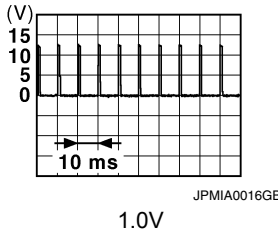

Terminal No. (Wire color)		Description		Condition		Value (Approx.)
		Signal name	Input/ Output			
(+)	(-)					
83 (L)	Ground	ACC relay control	Output	Ignition switch	OFF	0V
					ACC or ON	Battery voltage
84 (Y/R)	Ground	CVT shift selector	Output	—		Battery voltage
87 (G/B)	Ground	Selector lever P position switch	Input	Selector lever	P position	0V
					Any position other than P	Battery voltage
88 (R)	Ground	Front door RH request switch	Input	Front door RH request switch	ON (pressed)	0V
					OFF (not pressed)	
89 (R)	Ground	Front door LH request switch	Input	Front door LH request switch	ON (pressed)	0V
					OFF (not pressed)	
90 (Y)	Ground	Blower fan motor relay control	Output	Ignition switch	OFF or ACC	0V
					ON	Battery voltage
91 (L/R)	Ground	Remote keyless entry receiver power supply	Output	Ignition switch OFF		Battery voltage

A  
B  
C  
D  
E  
F  
G  
H  
I  
J  
K  
L  
M  
O  
P

WCS

# BCM (BODY CONTROL MODULE)

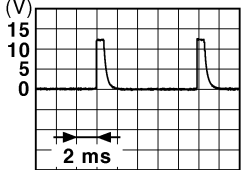
## < ECU DIAGNOSIS INFORMATION >

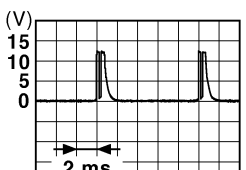
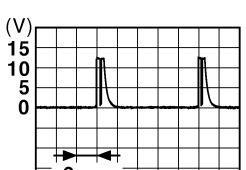
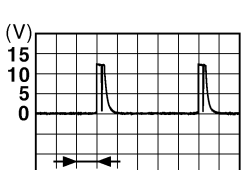
Terminal No. (Wire color)		Description		Condition	Value (Approx.)
(+)	(-)	Signal name	Input/ Output		
95 (R/W)	Ground	Combination switch INPUT 1	Output	Combination switch (Wiper intermittent dial 4)	All switch OFF <div style="text-align: right;">  <p style="text-align: right;">1.4V</p> </div>
					Turn signal switch LH <div style="text-align: right;">  <p style="text-align: right;">1.3V</p> </div>
					Turn signal switch RH <div style="text-align: right;">  <p style="text-align: right;">1.3V</p> </div>
					Front wiper switch LO <div style="text-align: right;">  <p style="text-align: right;">1.3V</p> </div>
					Front washer switch ON <div style="text-align: right;">  <p style="text-align: right;">1.3V</p> </div>

# BCM (BODY CONTROL MODULE)

## < ECU DIAGNOSIS INFORMATION >

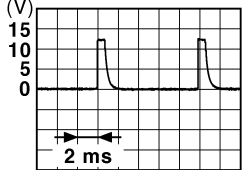
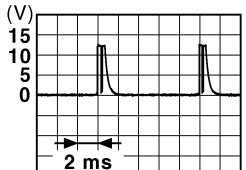
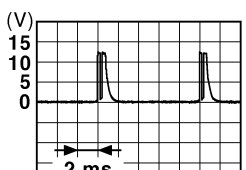
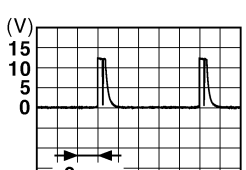

Terminal No. (Wire color)		Description		Condition	Value (Approx.)
(+)	(-)	Signal name	Input/ Output		
96 (P/B)	Ground	Combination switch INPUT 4	Output Combination switch	All switch OFF (Wiper intermittent dial 4)	 <p style="text-align: center;">1.4V</p>
				Lighting switch AUTO (Wiper intermittent dial 4)	 <p style="text-align: center;">1.3V</p>
				Lighting switch 1ST (Wiper intermittent dial 4)	 <p style="text-align: center;">1.3V</p>
				Any of the conditions below with all switch OFF	<ul style="list-style-type: none"> <li>• Wiper intermittent dial 1</li> <li>• Wiper intermittent dial 5</li> <li>• Wiper intermittent dial 6</li> </ul>  <p style="text-align: center;">1.3V</p>

A  
B  
C  
D  
E  
F  
G  
H  
I  
J  
K  
L  
M  
O  
P

WCS

# BCM (BODY CONTROL MODULE)

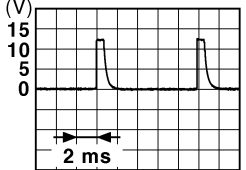
## < ECU DIAGNOSIS INFORMATION >

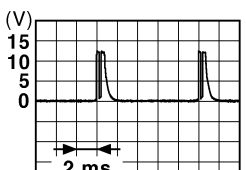
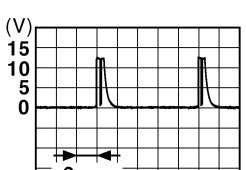
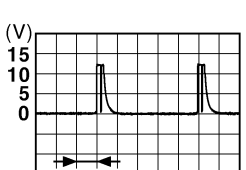
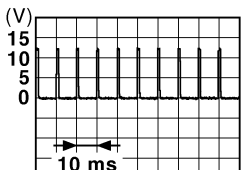
Terminal No. (Wire color)		Description		Condition	Value (Approx.)	
(+)	(-)	Signal name	Input/ Output			
97 (R/B)	Ground	Combination switch INPUT 2	Output	Combination switch (Wiper intermittent dial 4)	All switch OFF	 <p style="text-align: right;">1.4V</p>
					Lighting switch flash-to-pass	 <p style="text-align: right;">1.3V</p>
					Lighting switch 2ND	 <p style="text-align: right;">1.3V</p>
					Front wiper switch INT	 <p style="text-align: right;">1.3V</p>
					Front wiper switch HI	 <p style="text-align: right;">1.3V</p>
					Pressed	0 V
98 (G/O)	Ground	Hazard switch	Input	Hazard switch	Not pressed	 <p style="text-align: right;">1.1V</p>

# BCM (BODY CONTROL MODULE)

## < ECU DIAGNOSIS INFORMATION >

Terminal No. (Wire color)		Description		Condition	Value (Approx.)	
(+)	(-)	Signal name	Input/ Output			
103 (V)	Ground	Trunk lid opening.	Output	Trunk lid	Open (trunk lid opener actuator is activated)	Battery voltage
					Close (trunk lid opener actuator is not activated)	0V
110 (V/W)	Ground	Trunk room lamp	Output	Trunk room lamp	ON	0V
					OFF	Battery voltage
114 (B)	Ground	Trunk room antenna 1 (-)	Output	Ignition switch OFF	When Intelligent Key is in the passenger compartment	<p style="text-align: right; font-size: small;">JMKIA0062GB</p>
					When Intelligent Key is not in the passenger compartment	<p style="text-align: right; font-size: small;">JMKIA0063GB</p>
115 (W)	Ground	Trunk room antenna 1 (+)	Output	Ignition switch OFF	When Intelligent Key is in the passenger compartment	<p style="text-align: right; font-size: small;">JMKIA0062GB</p>
					When Intelligent Key is not in the passenger compartment	<p style="text-align: right; font-size: small;">JMKIA0063GB</p>

A  
B  
C  
D  
E  
F  
G  
H  
I  
J  
K  
L  
M  
O  
P

WCS

# BCM (BODY CONTROL MODULE)

## < ECU DIAGNOSIS INFORMATION >

Terminal No. (Wire color)		Description		Condition	Value (Approx.)
(+)	(-)	Signal name	Input/ Output		
118 (L/O)	Ground	Rear bumper antenna (-)	Output	When the trunk lid request switch is operated with ignition switch OFF	<p style="text-align: right; font-size: small;">JMKIA0062GB</p>
				When Intelligent Key is not in the antenna detection area	<p style="text-align: right; font-size: small;">JMKIA0063GB</p>
119 (BR/W)	Ground	Rear bumper antenna (+)	Output	When the trunk lid request switch is operated with ignition switch OFF	<p style="text-align: right; font-size: small;">JMKIA0062GB</p>
				When Intelligent Key is not in the antenna detection area	<p style="text-align: right; font-size: small;">JMKIA0063GB</p>
127 (BR/W)	Ground	Ignition relay (IPDM E/R) control	Output	Ignition switch	OFF or ACC Battery voltage ON 0V
130 (W)	Ground	Trunk room lamp switch	Input	Trunk room lamp switch	<p style="text-align: right; font-size: small;">JPMIA0011GB</p> <p style="text-align: center;">11.8V</p>
				OFF (trunk is closed)	
				ON (trunk is open)	0V
132 (R)	Ground	Starter motor relay control	Output	Ignition switch	ON Battery voltage OFF (trunk is closed) 0V
				ON	0V



# BCM (BODY CONTROL MODULE)

## < ECU DIAGNOSIS INFORMATION >

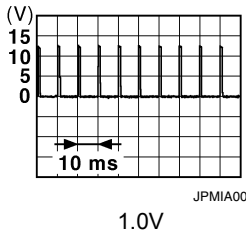
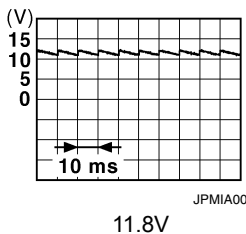
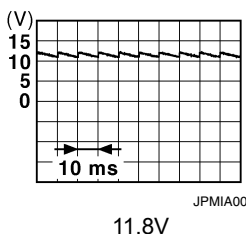
Terminal No. (Wire color)		Description		Condition	Value (Approx.)
		Signal name	Input/ Output		
(+)	(-)				
140 (BR)	Ground	Engine switch (push switch)	Input	Engine switch (push switch)	Pressed 0V
				Not pressed Battery voltage	
141 (BR)	Ground	Trunk opener request switch	Input	Trunk opener request switch	ON (pressed) 0V
				OFF (not pressed)	
144 (GR)	Ground	Request switch buzzer	Output	Request switch buzzer	Sounding 0V
				Not sounding Battery voltage	
147 (L/R)	Ground	Trunk lid opener switch	Input	Trunk lid opener switch	Pressed 0V
				Not pressed Battery voltage	
148 (R/W)	Ground	Rear door RH switch	Input	Rear door RH switch	OFF (when rear door RH closes)
				ON (when rear door RH opens)	
149 (R/B)	Ground	Rear door LH switch	Input	Rear door LH switch	OFF (when rear door LH closes)
				ON (when rear door LH opens)	

### Fail Safe

INFOID:000000010054778

WCS

Display contents of CONSULT	Fail-safe	Cancellation
B2190: NATS ANTENNA AMP	Inhibit engine cranking	Erase DTC
B2191: DIFFERENCE OF KEY	Inhibit engine cranking	Erase DTC
B2192: ID DISCORD BCM-ECM	Inhibit engine cranking	Erase DTC
B2193: CHAIN OF BCM-ECM	Inhibit engine cranking	Erase DTC
B2195: ANTI-SCANNING	Inhibit engine cranking	Erase DTC
B2560: STARTER CONT RELAY	Inhibit engine cranking	500 ms after the following CAN signal communication status has become consistent <ul style="list-style-type: none"> <li>• Starter control relay signal</li> <li>• Starter relay status signal</li> </ul>

# BCM (BODY CONTROL MODULE)

## < ECU DIAGNOSIS INFORMATION >

Display contents of CONSULT	Fail-safe	Cancellation
B2562: LO VOLTAGE	Inhibit engine cranking	100 ms after the power supply voltage increases to more than 8.8 V
B2608: STARTER RELAY	Inhibit engine cranking	500 ms after the following signal communication status becomes consistent <ul style="list-style-type: none"> <li>• Starter motor relay control signal</li> <li>• Starter relay status signal (CAN)</li> </ul>
B260A: IGNITION RELAY	Inhibit engine cranking	500 ms after the following conditions are fulfilled <ul style="list-style-type: none"> <li>• IGN relay (IPDM E/R) control signal: OFF (Battery voltage)</li> <li>• Ignition ON signal (CAN to IPDM E/R): OFF (Request signal)</li> <li>• Ignition ON signal (CAN from IPDM E/R): OFF (Condition signal)</li> </ul>
B260F: ENG STATE SIG LOST	Maintains the power supply position attained at the time of DTC detection	When any of the following conditions is fulfilled <ul style="list-style-type: none"> <li>• Power position changes to ACC</li> <li>• Receives engine status signal (CAN)</li> </ul>
B2617: STARTER RELAY CIRC	Inhibit engine cranking	1 second after the starter motor relay control inside BCM becomes normal
B2618: BCM	Inhibit engine cranking	1 second after the ignition relay (IPDM E/R) control inside BCM becomes normal
B26E1: ENG STATE NO RECIV	Inhibit engine cranking	When any of the following conditions are fulfilled <ul style="list-style-type: none"> <li>• Power position changes to ACC</li> <li>• Receives engine status signal (CAN)</li> </ul>

## DTC Inspection Priority Chart

INFOID:0000000010054779

If some DTCs are displayed at the same time, perform inspections one by one based on the following priority chart.

Priority	DTC
1	<ul style="list-style-type: none"> <li>• B2562: LO VOLTAGE</li> </ul>
2	<ul style="list-style-type: none"> <li>• U1000: CAN COMM CIRCUIT</li> <li>• U1010: CONTROL UNIT (CAN)</li> </ul>
3	<ul style="list-style-type: none"> <li>• B2190: NATS ANTENNA AMP</li> <li>• B2191: DIFFERENCE OF KEY</li> <li>• B2192: ID DISCORD BCM-ECM</li> <li>• B2193: CHAIN OF BCM-ECM</li> </ul>
4	<ul style="list-style-type: none"> <li>• B2553: IGNITION RELAY</li> <li>• B2555: STOP LAMP</li> <li>• B2556: PUSH-BTN IGN SW</li> <li>• B2557: VEHICLE SPEED</li> <li>• B2560: STARTER CONT RELAY</li> <li>• B2601: SHIFT POSITION</li> <li>• B2602: SHIFT POSITION</li> <li>• B2603: SHIFT POSI STATUS</li> <li>• B2604: PNP SWITCH</li> <li>• B2605: PNP SWITCH</li> <li>• B2608: STARTER RELAY</li> <li>• B260A: IGNITION RELAY</li> <li>• B260F: ENG STATE SIG LOST</li> <li>• B2614: ACC RELAY CIRC</li> <li>• B2615: BLOWER RELAY CIRC</li> <li>• B2616: IGN RELAY CIRC</li> <li>• B2617: STARTER RELAY CIRC</li> <li>• B2618: BCM</li> <li>• B261A: PUSH-BTN IGN SW</li> <li>• B26E1: ENG STATE NO RECIV</li> <li>• C1729: VHCL SPEED SIG ERR</li> <li>• U0415: VEHICLE SPEED SIG</li> </ul>

# BCM (BODY CONTROL MODULE)

## < ECU DIAGNOSIS INFORMATION >

Priority	DTC	
5	<ul style="list-style-type: none"> <li>• C1704: LOW PRESSURE FL</li> <li>• C1705: LOW PRESSURE FR</li> <li>• C1706: LOW PRESSURE RR</li> <li>• C1707: LOW PRESSURE RL</li> <li>• C1708: [NO DATA] FL</li> <li>• C1709: [NO DATA] FR</li> <li>• C1710: [NO DATA] RR</li> <li>• C1711: [NO DATA] RL</li> <li>• C1712: [CHECKSUM ERR] FL</li> <li>• C1713: [CHECKSUM ERR] FR</li> <li>• C1714: [CHECKSUM ERR] RR</li> <li>• C1715: [CHECKSUM ERR] RL</li> <li>• C1716: [PRESSDATA ERR] FL</li> <li>• C1717: [PRESSDATA ERR] FR</li> <li>• C1718: [PRESSDATA ERR] RR</li> <li>• C1719: [PRESSDATA ERR] RL</li> <li>• C1720: [CODE ERR] FL</li> <li>• C1721: [CODE ERR] FR</li> <li>• C1722: [CODE ERR] RR</li> <li>• C1723: [CODE ERR] RL</li> <li>• C1724: [BATT VOLT LOW] FL</li> <li>• C1725: [BATT VOLT LOW] FR</li> <li>• C1726: [BATT VOLT LOW] RR</li> <li>• C1727: [BATT VOLT LOW] RL</li> <li>• C1734: CONTROL UNIT</li> </ul>	A B C D E F G
6	<ul style="list-style-type: none"> <li>• B2622: INSIDE ANTENNA</li> <li>• B2623: INSIDE ANTENNA</li> </ul>	H

## DTC Index

INFOID:0000000010054780

### NOTE:

- Details of time display
- CRNT: Displays when there is a malfunction now or after returning to the normal condition until turning ignition switch OFF → ON again.
- 1 - 39: Displayed if any previous malfunction is present when current condition is normal. It increases 1 → 2 → 3...38 → 39 after returning to the normal condition whenever ignition switch OFF → ON. The counter remains at 39 even if the number of cycles exceeds it. It is counted from 1 again when turning ignition switch OFF → ON after returning to the normal condition if the malfunction is detected again.

CONSULT display	Fail-safe	Intelligent Key warning lamp ON	Tire pressure monitor warning lamp ON	Reference page	
No DTC is detected. further testing may be required.	—	—	—	—	M
U1000: CAN COMM CIRCUIT	—	—	—	<a href="#">BCS-32</a>	WCS
U1010: CONTROL UNIT (CAN)	—	—	—	<a href="#">BCS-33</a>	
U0415: VEHICLE SPEED SIG	—	—	—	<a href="#">BCS-34</a>	
B2190: NATS ANTENNA AMP	×	—	—	<a href="#">SEC-37</a>	O
B2191: DIFFERENCE OF KEY	×	—	—	<a href="#">SEC-40</a>	
B2192: ID DISCORD BCM-ECM	×	—	—	<a href="#">SEC-41</a>	
B2193: CHAIN OF BCM-ECM	×	—	—	<a href="#">SEC-42</a>	P
B2553: IGNITION RELAY	—	—	—	<a href="#">PCS-46</a>	
B2555: STOP LAMP	—	—	—	<a href="#">SEC-43</a>	
B2556: PUSH-BTN IGN SW	—	×	—	<a href="#">SEC-46</a>	
B2557: VEHICLE SPEED	×	×	—	<a href="#">SEC-48</a>	
B2560: STARTER CONT RELAY	×	×	—	<a href="#">SEC-49</a>	

## BCM (BODY CONTROL MODULE)

### < ECU DIAGNOSIS INFORMATION >

CONSULT display	Fail-safe	Intelligent Key warning lamp ON	Tire pressure monitor warning lamp ON	Reference page
B2562: LOW VOLTAGE	—	—	—	<a href="#">BCS-35</a>
B2601: SHIFT POSITION	×	×	—	<a href="#">SEC-50</a>
B2602: SHIFT POSITION	×	×	—	<a href="#">SEC-53</a>
B2603: SHIFT POSI STATUS	×	×	—	<a href="#">SEC-56</a>
B2604: PNP SWITCH	×	×	—	<a href="#">SEC-59</a>
B2605: PNP SWITCH	×	×	—	<a href="#">SEC-61</a>
B2608: STARTER RELAY	×	×	—	<a href="#">SEC-63</a>
B260A: IGNITION RELAY	×	×	—	<a href="#">PCS-48</a>
B260F: ENG STATE SIG LOST	×	×	—	<a href="#">SEC-65</a>
B2614: ACC RELAY CIRC	—	×	—	<a href="#">PCS-50</a>
B2615: BLOWER RELAY CIRC	—	×	—	<a href="#">PCS-53</a>
B2616: IGN RELAY CIRC	—	×	—	<a href="#">PCS-56</a>
B2617: STARTER RELAY CIRC	×	×	—	<a href="#">SEC-67</a>
B2618: BCM	×	×	—	<a href="#">PCS-59</a>
B261A: PUSH-BTN IGN SW	—	×	—	<a href="#">PCS-60</a>
B2622: INSIDE ANTENNA	—	—	—	<a href="#">DLK-60</a>
B2623: INSIDE ANTENNA	—	—	—	<a href="#">DLK-63</a>
B26E1: ENG STATE NO RES	×	×	—	<a href="#">SEC-66</a>
C1704: LOW PRESSURE FL	—	—	×	<a href="#">WT-43</a>
C1705: LOW PRESSURE FR	—	—	×	<a href="#">WT-43</a>
C1706: LOW PRESSURE RR	—	—	×	<a href="#">WT-43</a>
C1707: LOW PRESSURE RL	—	—	×	<a href="#">WT-43</a>
C1708: [NO DATA] FL	—	—	×	<a href="#">WT-13</a>
C1709: [NO DATA] FR	—	—	×	<a href="#">WT-13</a>
C1710: [NO DATA] RR	—	—	×	<a href="#">WT-13</a>
C1711: [NO DATA] RL	—	—	×	<a href="#">WT-13</a>
C1712: [CHECKSUM ERR] FL	—	—	×	<a href="#">WT-15</a>
C1713: [CHECKSUM ERR] FR	—	—	×	<a href="#">WT-15</a>
C1714: [CHECKSUM ERR] RR	—	—	×	<a href="#">WT-15</a>
C1715: [CHECKSUM ERR] RL	—	—	×	<a href="#">WT-15</a>
C1716: [PRESSDATA ERR] FL	—	—	×	<a href="#">WT-17</a>
C1717: [PRESSDATA ERR] FR	—	—	×	<a href="#">WT-17</a>
C1718: [PRESSDATA ERR] RR	—	—	×	<a href="#">WT-17</a>
C1719: [PRESSDATA ERR] RL	—	—	×	<a href="#">WT-17</a>
C1720: [CODE ERR] FL	—	—	×	<a href="#">WT-15</a>
C1721: [CODE ERR] FR	—	—	×	<a href="#">WT-15</a>
C1722: [CODE ERR] RR	—	—	×	<a href="#">WT-15</a>
C1723: [CODE ERR] RL	—	—	×	<a href="#">WT-15</a>
C1724: [BATT VOLT LOW] FL	—	—	×	<a href="#">WT-15</a>
C1725: [BATT VOLT LOW] FR	—	—	×	<a href="#">WT-15</a>
C1726: [BATT VOLT LOW] RR	—	—	×	<a href="#">WT-15</a>
C1727: [BATT VOLT LOW] RL	—	—	×	<a href="#">WT-15</a>

# BCM (BODY CONTROL MODULE)

## < ECU DIAGNOSIS INFORMATION >

CONSULT display	Fail-safe	Intelligent Key warning lamp ON	Tire pressure monitor warning lamp ON	Reference page
C1729: VHCL SPEED SIG ERR	—	—	×	<a href="#">WT-19</a>
C1734: CONTROL UNIT	—	—	×	<a href="#">WT-20</a>

A

B

C

D

E

F

G

H

I

J

K

L

M

WCS

O

P

# WARNING CHIME SYSTEM

< WIRING DIAGRAM >

## WIRING DIAGRAM

### WARNING CHIME SYSTEM

Wiring Diagram

INFOID:000000010049251

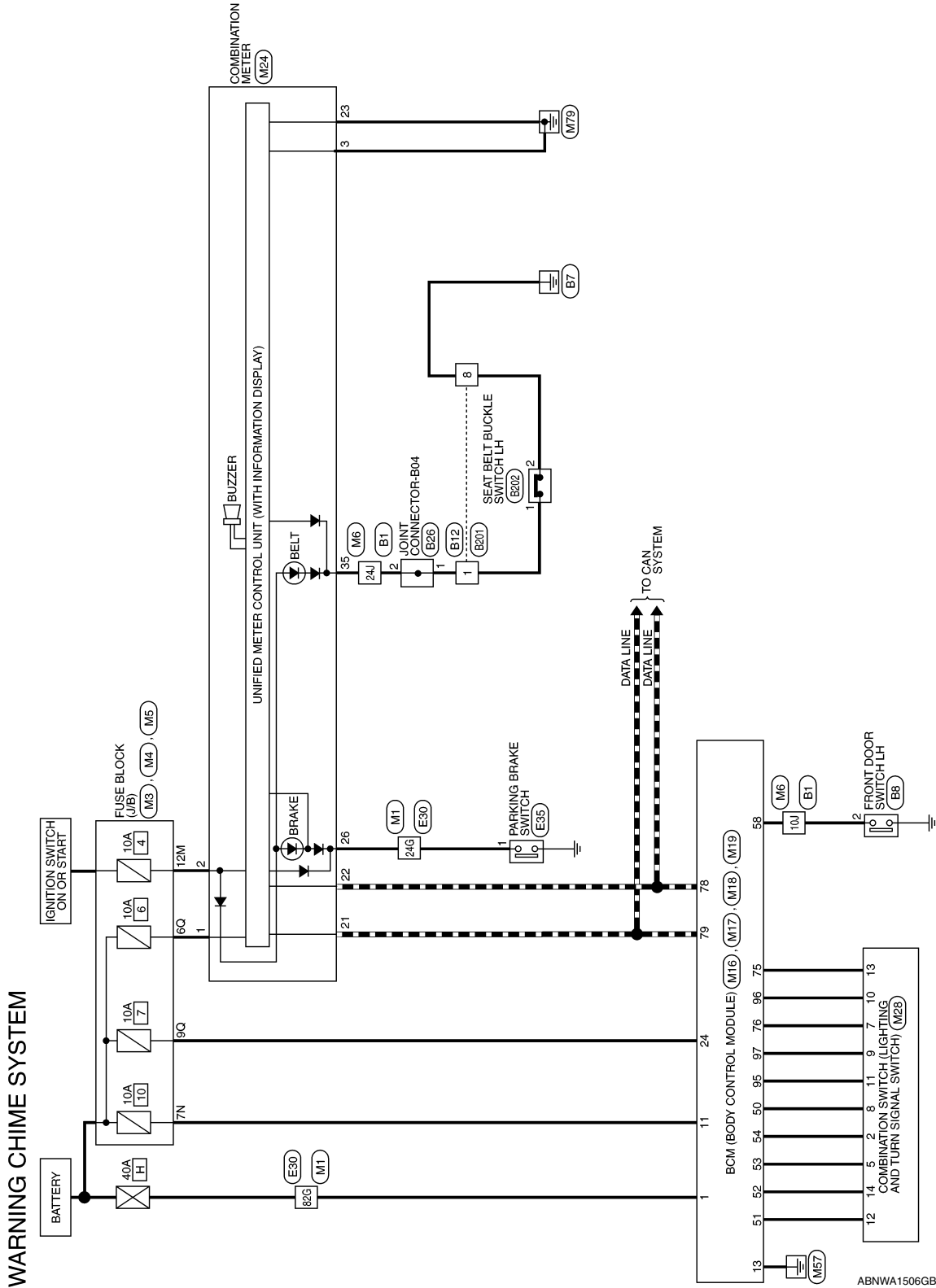

ABNWA1506GB

# WARNING CHIME SYSTEM

< WIRING DIAGRAM >

## WARNING CHIME SYSTEM CONNECTORS

Connector No.	M1
Connector Name	WIRE TO WIRE
Connector Color	WHITE

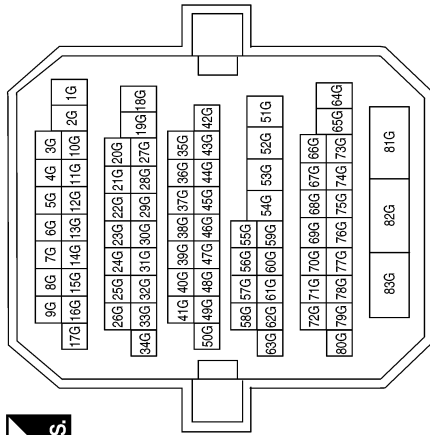

Terminal No.	Color of Wire	Signal Name
24G	G/R	-
82G	W/B	-

Connector No.	M3
Connector Name	FUSE BLOCK (J/B)
Connector Color	WHITE

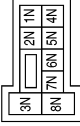

Terminal No.	Color of Wire	Signal Name
7N	Y/R	-

Connector No.	M4
Connector Name	FUSE BLOCK (J/B)
Connector Color	WHITE

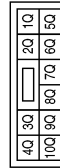

Terminal No.	Color of Wire	Signal Name
6Q	Y/R	-
9Q	R/W	-

Connector No.	M5
Connector Name	FUSE BLOCK (J/B)
Connector Color	WHITE



Terminal No.	Color of Wire	Signal Name
12M	O	-

ABNIA3740GB

A  
B  
C  
D  
E  
F  
G  
H  
I  
J  
K  
L  
M  
N  
O  
P

WCS

# WARNING CHIME SYSTEM

< WIRING DIAGRAM >

Connector No.	M16
Connector Name	BCM (BODY CONTROL MODULE)
Connector Color	BLACK



Terminal No.	Color of Wire	Signal Name
1	W/B	BATT (F/L)

Terminal No.	Color of Wire	Signal Name
10J	SB	-
24J	W/B	-

Connector No.	M6
Connector Name	WIRE TO WIRE
Connector Color	WHITE

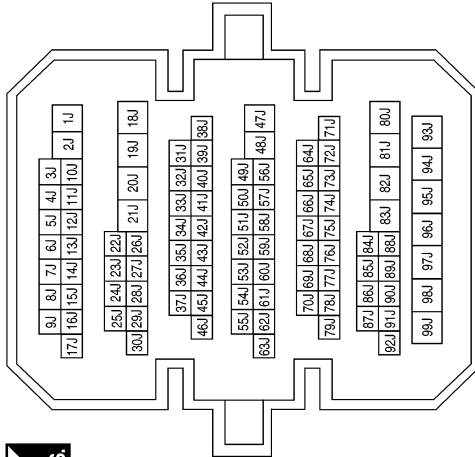

Terminal No.	Color of Wire	Signal Name
24	R/W	BRAKE SW 1
50	LG/B	INPUT 5
51	L/W	INPUT 1
52	G/B	INPUT 2
53	LG/R	INPUT 3
54	G/Y	INPUT 4
58	SB	DR DOOR SW

Connector No.	M18
Connector Name	BCM (BODY CONTROL MODULE)
Connector Color	GREEN

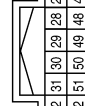

39	38	37	36	35	34	33	32	31	30	29	28	27	26	25	24	23	22	21	20	19	18	17	16	15	14	13	12	11	10	9	8	7	6	5	4	3	2	1
----	----	----	----	----	----	----	----	----	----	----	----	----	----	----	----	----	----	----	----	----	----	----	----	----	----	----	----	----	----	---	---	---	---	---	---	---	---	---

Connector No.	M17
Connector Name	BCM (BODY CONTROL MODULE)
Connector Color	WHITE

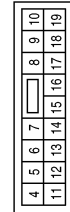

Terminal No.	Color of Wire	Signal Name
11	Y/R	BAT BCM FUSE
13	B	GND1

ABNIA3741GB



# WARNING CHIME SYSTEM

< WIRING DIAGRAM >

Connector No.	M28
Connector Name	COMBINATION SWITCH
Connector Color	WHITE

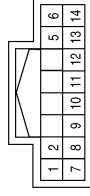

Terminal No.	Color of Wire	Signal Name
2	G/Y	-
5	LG/R	-
7	R/G	-
8	LG/B	-
9	R/B	-
10	P/B	-
11	R/W	-
12	L/W	-
13	R/Y	-
14	G/B	-

Connector No.	M24
Connector Name	COMBINATION METER
Connector Color	WHITE

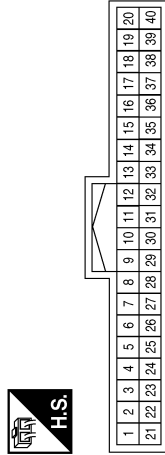

Terminal No.	Color of Wire	Signal Name
1	Y/R	BAT
2	O	IGN
3	B	GND (POWER)
21	L	CAN-H
22	P	CAN-L
23	B	GND (CIRCUIT)
26	G/R	PKB
35	W/B	DR BELT

Connector No.	M19
Connector Name	BCM (BODY CONTROL MODULE)
Connector Color	BLACK

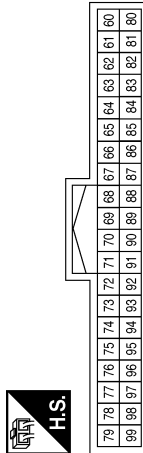

Terminal No.	Color of Wire	Signal Name
75	R/Y	OUTPUT 5
76	R/G	OUTPUT 3
78	P	CAN-L
79	L	CAN-H
95	R/W	OUTPUT 1
96	P/B	OUTPUT 4
97	R/B	OUTPUT 2

A  
B  
C  
D  
E  
F  
G  
H  
I  
J  
K  
L  
M  
N  
O  
P

WCS

ABNIA5171GB

# WARNING CHIME SYSTEM

< WIRING DIAGRAM >

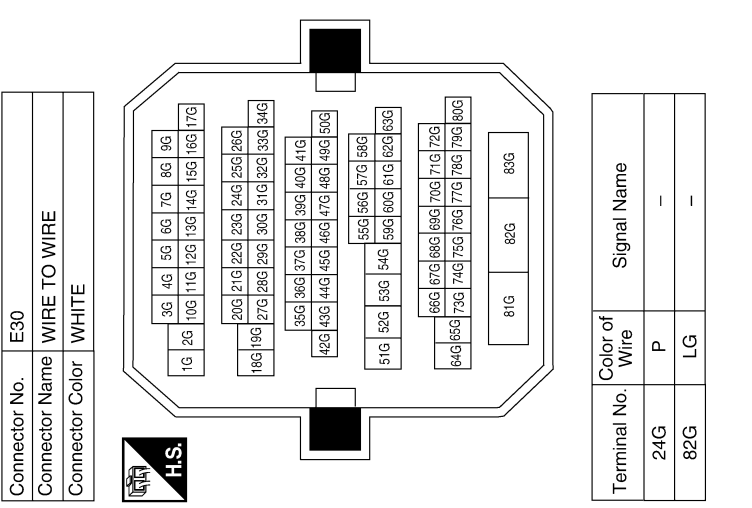
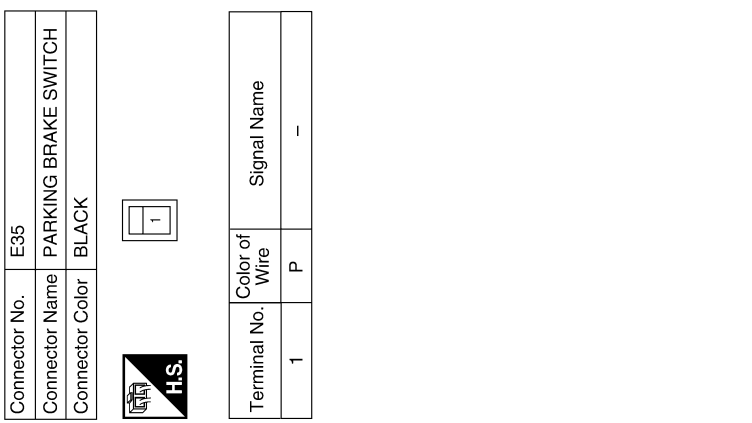
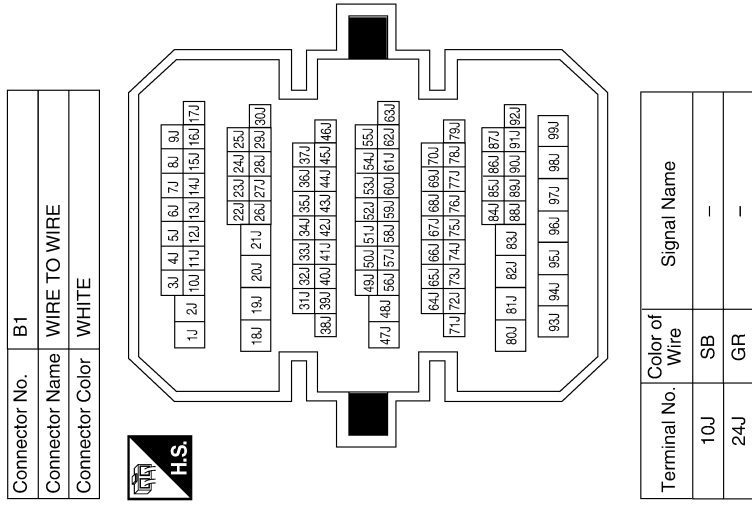

ABNIA2414GB

# WARNING CHIME SYSTEM

## < WIRING DIAGRAM >

Connector No.	B26
Connector Name	JOINT CONNECTOR-B04
Connector Color	WHITE



Terminal No.	Color of Wire	Signal Name
1	GR	-
2	GR	-

Connector No.	B12
Connector Name	WIRE TO WIRE
Connector Color	WHITE

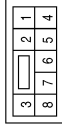

Terminal No.	Color of Wire	Signal Name
1	GR	-
8	BW	-

Connector No.	B8
Connector Name	FRONT DOOR SWITCH LH
Connector Color	WHITE

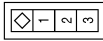

Terminal No.	Color of Wire	Signal Name
2	SB	-

Connector No.	B202
Connector Name	SEAT BELT BUCKLE SWITCH LH
Connector Color	WHITE

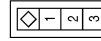

Terminal No.	Color of Wire	Signal Name
1	L	-
2	B	-

Connector No.	B201
Connector Name	WIRE TO WIRE
Connector Color	WHITE



Terminal No.	Color of Wire	Signal Name
1	L	-
8	B	-

ABNIA5172GB

A  
B  
C  
D  
E  
F  
G  
H  
I  
J  
K  
L  
M  
O  
P

WCS

# THE PARKING BRAKE RELEASE WARNING CONTINUES SOUNDING, OR DOES NOT SOUND

< SYMPTOM DIAGNOSIS >

## SYMPTOM DIAGNOSIS

### THE PARKING BRAKE RELEASE WARNING CONTINUES SOUNDING, OR DOES NOT SOUND

#### Description

INFOID:0000000010049252

- The parking brake warning buzzer sounds continuously during vehicle travel though the parking brake is released
- The parking brake warning buzzer does not sound at all even though driving the vehicle with the parking brake applied.

#### Diagnosis Procedure

INFOID:0000000010049253

#### 1. CHECK PARKING BRAKE WARNING LAMP

1. Start the engine.
2. Check the operation of the brake warning lamp by operating the parking brake.

**Parking brake ON** : ON  
**Parking brake OFF** : OFF

#### Is the inspection result normal?

- YES >> Replace the combination meter. Refer to [MWI-122, "Removal and Installation"](#).  
NO >> GO TO 2

#### 2. CHECK PARKING BRAKE SWITCH SIGNAL CIRCUIT

Perform inspection of the parking brake switch signal circuit. Refer to [MWI-44, "Diagnosis Procedure"](#).

#### Is the inspection result normal?

- YES >> GO TO 3  
NO >> Repair or replace harness.

#### 3. CHECK PARKING BRAKE SWITCH UNIT

Perform a unit inspection for the parking brake switch. Refer to [MWI-44, "Component Inspection"](#).

#### Is the inspection result normal?

- YES >> Replace the combination meter. Refer to [MWI-122, "Removal and Installation"](#).  
NO >> Replace the parking brake switch.

# THE LIGHT REMINDER WARNING DOES NOT SOUND

< SYMPTOM DIAGNOSIS >

---

## THE LIGHT REMINDER WARNING DOES NOT SOUND

### Description

INFOID:000000010049254

Light reminder warning does not sound even though headlamp is illuminated.

### Diagnosis Procedure

INFOID:000000010049255

---

#### 1. CHECK COMBINATION SWITCH (LIGHTING AND TURN SIGNAL SWITCH) OPERATION

Check that the headlamps operate normally by operating the combination switch (lighting and turn signal switch).

Do they operate normally?

YES >> GO TO 2

NO >> Refer to [EXL-6. "Work Flow"](#).

---

#### 2. CHECK FRONT DOOR SWITCH LH SIGNAL CIRCUIT

Perform inspection of the front door switch LH signal circuit. Refer to [DLK-67. "Diagnosis Procedure"](#).

Is the inspection result normal?

YES >> GO TO 3

NO >> Repair or replace harness.

---

#### 3. CHECK FRONT DOOR SWITCH LH

Perform a unit inspection for the front door switch LH. Refer to [DLK-69. "Component Inspection"](#).

Is the inspection result normal?

YES >> Replace the BCM. Refer to [BCS-79. "Removal and Installation"](#).

NO >> Replace the front door switch LH.

A  
B  
C  
D  
E  
F  
G  
H  
I  
J  
K  
L  
M  
O  
P

WCS

# THE SEAT BELT WARNING CONTINUES SOUNDING, OR DOES NOT SOUND

< SYMPTOM DIAGNOSIS >

## THE SEAT BELT WARNING CONTINUES SOUNDING, OR DOES NOT SOUND

### Description

INFOID:000000010049256

- Seat belt warning does not sound even though driver seat belt is not fastened.
- Seat belt warning sounds even though driver seat belt is fastened.

### Diagnosis Procedure

INFOID:000000010049257

#### 1. CHECK WARNING CHIME OPERATION

With the driver door open, turn lighting switch to 1st or 2nd position.

Does warning chime sound?

YES >> GO TO 2

NO >> Replace combination meter. Refer to [MWI-122, "Removal and Installation"](#).

#### 2. CHECK SEAT BELT WARNING LAMP

1. Turn ignition switch ON.
2. Check the operation of the seat belt warning lamp in the combination meter.

**Seat belt fastened** : OFF

**Seat belt not fastened** : ON

Is the inspection result normal?

YES >> Replace BCM. Refer to [BCS-79, "Removal and Installation"](#).

NO >> GO TO 3

#### 3. CHECK SEAT BELT BUCKLE SWITCH LH CIRCUIT

Perform inspection of the seat belt buckle switch LH circuit. Refer to [WCS-21, "Diagnosis Procedure"](#).

Is the inspection result normal?

YES >> GO TO 4

NO >> Repair or replace harness.

#### 4. CHECK SEAT BELT BUCKLE SWITCH LH

Perform a unit inspection for the seat belt buckle switch LH. Refer to [WCS-22, "Component Inspection"](#).

Is the inspection result normal?

YES >> Replace the combination meter. Refer to [MWI-122, "Removal and Installation"](#).

NO >> Replace the seat belt buckle switch LH. Refer to [SE-68, "Removal and Installation"](#) (with climate controlled seats) or [SE-126, "Removal and Installation"](#) (without climate controlled seats).

# PRECAUTIONS

< PRECAUTION >

## PRECAUTION

### PRECAUTIONS

#### Precaution for Supplemental Restraint System (SRS) "AIR BAG" and "SEAT BELT PRE-TENSIONER"

INFOID:000000010054785

The Supplemental Restraint System such as "AIR BAG" and "SEAT BELT PRE-TENSIONER", used along with a front seat belt, helps to reduce the risk or severity of injury to the driver and front passenger for certain types of collision. This system includes seat belt switch inputs and dual stage front air bag modules. The SRS system uses the seat belt switches to determine the front air bag deployment, and may only deploy one front air bag, depending on the severity of a collision and whether the front occupants are belted or unbelted. Information necessary to service the system safely is included in the SR and SB section of this Service Manual.

#### **WARNING:**

- To avoid rendering the SRS inoperative, which could increase the risk of personal injury or death in the event of a collision which would result in air bag inflation, all maintenance must be performed by an authorized NISSAN/INFINITI dealer.
- Improper maintenance, including incorrect removal and installation of the SRS, can lead to personal injury caused by unintentional activation of the system. For removal of Spiral Cable and Air Bag Module, see the SR section.
- Do not use electrical test equipment on any circuit related to the SRS unless instructed to in this Service Manual. SRS wiring harnesses can be identified by yellow and/or orange harnesses or harness connectors.

#### PRECAUTIONS WHEN USING POWER TOOLS (AIR OR ELECTRIC) AND HAMMERS

#### **WARNING:**

- When working near the Airbag Diagnosis Sensor Unit or other Airbag System sensors with the Ignition ON or engine running, DO NOT use air or electric power tools or strike near the sensor(s) with a hammer. Heavy vibration could activate the sensor(s) and deploy the air bag(s), possibly causing serious injury.
- When using air or electric power tools or hammers, always switch the Ignition OFF, disconnect the battery and wait at least 3 minutes before performing any service.

A  
B  
C  
D  
E  
F  
G  
H  
I  
J  
K  
L  
M  
O  
P

WCS